



# Product Catalogue

Produkt Katalog - Catalogue Général - Catalogo Prodotti - Catálogo

ТСК-Акватория  
г. Екатеринбург,  
ул. Чапаева, д.1, оф. 7

(343) 257-52-11  
[www.masterural.ru](http://www.masterural.ru)  
[info@masterural.ru](mailto:info@masterural.ru)

TOGETHER WE BUILD DREAMS THAT INNOVATE



**Pentair Water**  
Pool and Spa™



# Content / Index / Inhaltsverzeichnis / Indice



Sandfilters / Sandfilteranlagen / Filtres à sable / Filtros de arena / Filtri a sabbia	3
Triton	3
Tagelus	3
Azur	4
Sandfilteranlagen / Sand Filter Systems / Groupes de filtration à sable / Grupos de filtración de arena / Gruppi filtranti a sabbia	5
Azur	5
Swimmey Kit	5
Commercial filters / Handelsüblichen Filter / Filtres commerciaux / Filtros comerciales / Filtri commerciali	6
Triton XL	6
Cartridge filters / Kartuschenfilter / Filtres à cartouche / Filtros de cartucho / Filtri a cartuccia	7
Clean & Clear Plus	7
D.E. Filters / Filtres à diatomée / Filtros de diatomeas / Filtri a diatomee	8
FNS Plus	8
Nautilus	8
Quad D.E.	8
Swimming Pool Pumps / Schwimmbadpumpen / Pompes pour piscine / Bombas para piscinas / Pompe per piscine	9
IntelliFlo	9
Whisperflo	9
Ultraflow	10
Challenger	10-11
Pinnacle	12
Swimmey	12
EQ Pump	12
Automatic Vacuum Pool Cleaners / Automatische Vacuum Schwimmbadreiner / Nettoyeur automatique pour piscines / Pulitori automatici lato aspirazione / Limpiafondos automáticos de aspiración para piscinas	13
E-Z Vac	13
New Kreepy Krauly	13
Kreepy Kadet	13
Lil Shark	14
Poolshark	14
Great White	14
Automatic Pressure Pool Cleaners / Automatische Pool - Druckreiniger / Nettoyeur automatique à pression / Limpiafondos automáticos a presión para piscinas / Pulitori automatici lato pressione	15
Letro Legend	15
Letro Legend II	15
Letro Sweep	15
Electrical Pool Cleaners / Automatischer Robotreiniger / Robot nettoyeur de piscine / Limpiafondos automáticos eléctricos para piscinas / Pulitori automatici elettrici	16
KR730 Robot	16
KR720 Robot	16
KR700 Robot	16
White Goods / Kunststoffeinbauteile / Pièces à sceller / Piezas A Empotrar / Materiale per interno	17-20
Underwaterlights / Unterwasserscheinwerfer / Eclairage subaquatique / Iluminación acuática / Fari per piscine	21
SAM	21
SAL	22
Amerlite	23
Aqualuminator	23
Sanitizers / Dosierer / Doseurs / Dosatori / Dosificadores	24
Salt chlorinators / Salz Chlorinator / Chlorinateurs de sel / Generatori di cloro a sale / Cloradores salinos	25
IntelliChlor	25
Aqualblue	25
Dosing & Measuring Equipment / Dosiersysteme und Messgeräte / Equipement de mesure et de dosage / Sistemi di dosaggio e misurazione / Equipos de dosificación y medición	26
Heating Equipment / Heizungen / Chauffage / Sistemi di riscaldamento / Equipos de calefacción	27
Gegenstromschwimmanlage / Counter-Current Swimming Systems / Système de nage à contre-courant / Sistemi di nuoto controcorrente / Sistemas de natación contracorriente	28
Triton Jet	28
System 1200	28
System 2000	28
Maintenance accessories / Zubehör / Matériel d'entretien / Accessori / Accesorios	29-36



## TRITON

### Sandfilters / Sandfilteranlagen / Filtres à sable Filtros de arena / Filtri a sabbia



	F-19S8-TRV (TR 40)	F-24S8-TRV (TR 60)	F-30S8-TRV (TR 100)	F-36S8-TRV (TR 140)
<b>A</b>	825	955	1095	1200
<b>B</b>	400	400	610	610
<b>C</b>	480	610	762	914
<b>D</b>	252	252	302	302
<b>E</b>	120	120	160	160
<b>F</b>	70	70	70	70
<b>G</b>	463	530	590	657
<b>H</b>	524	592	671	738



Model Modell Modèle Modello Modelo	Flow Rates m <sup>3</sup> /h at 50 m <sup>3</sup> /h/m <sup>2</sup> Filterleistung m <sup>3</sup> /h bei 50 m <sup>3</sup> /h/m <sup>2</sup> Débit en m <sup>3</sup> /h basé sur 50 m <sup>3</sup> /h/m <sup>2</sup> Flusso max m <sup>3</sup> /h a 50 m <sup>3</sup> /h/m <sup>2</sup> Caudal máx. en m <sup>3</sup> /h a 50 m <sup>3</sup> /h/m <sup>2</sup>	Description Beschreibung Désignation Descrizione Descripción	List price € Listenpreis in € Prix de liste € Prezzo di listino € P.V.P. €
F-19S8-TRV	8,5	Ø19" (480mm) TR40*	540,00
F-24S8-TRV	14	Ø24" (610mm) TR60*	635,00
F-30S8-TRV	22	Ø30" (762mm) TR100*	940,00
F-36S8-TRV	23,5	Ø36" (914mm) TR140*	1 300,00

\* incl. 6-way valve / inkl. 6-Wege Ventil / avec vanne 6-voies / Inclusa valvola a 6 vie / Incluye válvula de 6 vías

### Replacement valves - Ersatzventile - Vannes de remplacement - Parti di ricambio - Válvulas de repuesto

E-26-1070	1 1/2" valve/ventil/vanne/valvoa/válvula for TR40-60	115,00
E-26-1071	2" valve/ventil/vanne/valvoa/válvula for TR100-140	168,00

## TAGELUS



	F-19T6-TAG (TA 40)	F-24T6-TAG (TA 60)	F-30T8-TAG (TA 100)
<b>A</b>	878	1009	1170
<b>B</b>	400	400	610
<b>C</b>	480	610	762
<b>D</b>	715	847	1026
<b>E</b>	774	904	1108

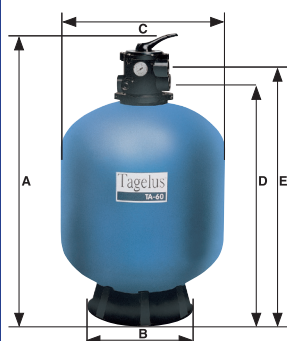

Model Modell Modèle Modello Modelo	Flow Rates m <sup>3</sup> /h at 50 m <sup>3</sup> /h/m <sup>2</sup> Filterleistung m <sup>3</sup> /h bei 50 m <sup>3</sup> /h/m <sup>2</sup> Débit en m <sup>3</sup> /h basé sur 50 m <sup>3</sup> /h/m <sup>2</sup> Flusso max m <sup>3</sup> /h a 50 m <sup>3</sup> /h/m <sup>2</sup> Caudal máx. en m <sup>3</sup> /h a 50 m <sup>3</sup> /h/m <sup>2</sup>	Description Beschreibung Désignation Descrizione Descripción	List price € Listenpreis in € Prix de liste € Prezzo di listino € P.V.P. €
F-19T6-TAG	8,5	Ø19" (480mm) TA40*	379,00
F-24T6-TAG	14	Ø24" (610mm) TA60*	456,00
F-30T8-TAG	22	Ø30" (762mm) TA100*	677,00

\* incl. 6-way valve / inkl. 6-Wege Ventil / avec vanne 6-voies / Inclusa valvola a 6 vie / Incluye válvula de 6 vías

### Replacement valves - Ersatzventile - Vannes de remplacement - Parti di ricambio - Válvulas de repuesto

E-27-2026	1 1/2" valve/ventil/vanne/valvoa/válvula for TA40-60	148,00
E-27-2029	2" valve/ventil/vanne/valvoa/válvula for TA100	164,00





## Sandfilters / Sandfilteranlagen / Filtres à sable Filtros de arena / Filtri a sabbia

### AZUR

**Side Mount**  
Vanne Latérale  
Montaggio laterale  
Montaje lateral



A	375	475	560	660
B	462	639	777	925
C	no base	709	860	995
D	no base	784	864	968
E	273	273	273	232
F	no base	489	489	489
G		288	372	527
H		160	160	160

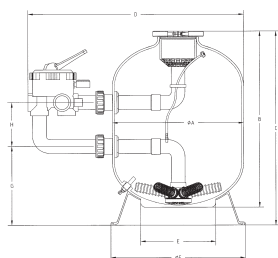

Model Modell Modèle Modello Modelo	Flow Rates m <sup>3</sup> /h at 50 m <sup>3</sup> /h/m <sup>2</sup> Filterleistung m <sup>3</sup> /h bei 50 m <sup>3</sup> /h/m <sup>2</sup> Débit en m <sup>3</sup> /h basé sur 50 m <sup>3</sup> /h/m <sup>2</sup> Flusso max m <sup>3</sup> /h a 50 m <sup>3</sup> /h/m <sup>2</sup> Caudal máx. en m <sup>3</sup> /h a 50 m <sup>3</sup> /h/m <sup>2</sup>	Description Beschreibung Désignation Descrizione Descripción	List price € Listenpreis in € Prix de liste € Prezzo di listino € P.V.P. €
F-19SF-AZ	9,0	Ø19" (480mm)*	390,00
F-22SF-AZ	12	Ø22" (560mm)*	436,00
F-26SF-AZ	16,5	Ø26" (660mm)*	530,00

\* incl. 6-way valve / inkl. 6-Wege Ventil / avec vanne 6-voies / Inclusa valvola a sei vie / Incluye válvula de 6 vías

### Replacement valves - Ersatzventile - Vannes de remplacement - Parti di ricambio - Válvulas de repuesto

E-26-1069	1 1/2" valve/ventil/vanne/valvoa/válvula	123,00
-----------	--	--------

### AZUR

**Top Mount**  
Vanne Top  
Montaggio superiore  
Montaje superior



A	375	475	560	660
B	462	639	777	925
C	no base	709	860	995
D	no base	784	864	968
E	273	273	273	232
F	no base	489	489	489
G		288	372	527
H		160	160	160

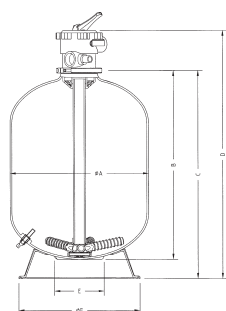

Model Modell Modèle Modello Modelo	Flow Rates m <sup>3</sup> /h at 50 m <sup>3</sup> /h/m <sup>2</sup> Filterleistung m <sup>3</sup> /h bei 50 m <sup>3</sup> /h/m <sup>2</sup> Débit en m <sup>3</sup> /h basé sur 50 m <sup>3</sup> /h/m <sup>2</sup> Flusso max m <sup>3</sup> /h a 50 m <sup>3</sup> /h/m <sup>2</sup> Caudal máx. en m <sup>3</sup> /h a 50 m <sup>3</sup> /h/m <sup>2</sup>	Description Beschreibung Désignation Descrizione Descripción	List price € Listenpreis in € Prix de liste € Prezzo di listino € P.V.P. €
F-15TF-AZ	6	Ø15" (380mm)*	262,00
F-19TF-AZ	9	Ø19" (480mm)**	303,00
F-22TF-AZ	12	Ø22" (560mm)**	388,00
F-26TF-AZ	16,5	Ø26" (660mm)**	475,00

\* incl. 4-way valve / inkl. 4-Wege Ventil / avec vanne 4-voies / Inclusa valvola a 4 vie / Incluye válvula de 4 vías  
\*\* incl. 6-way valve / inkl. 6-Wege Ventil / avec vanne 6-voies / Inclusa valvola a 6 vie / Incluye válvula de 6 vías

### Replacement valves - Ersatzventile - Vannes de remplacement - Parti di ricambio - Válvulas de repuesto

E-27-2030	1 1/2" 4-way valve/4-Wege Ventil/vanne 4-voies/valvoa a 4 vie/válvula de 4 vías	72,00
E-27-2026	1 1/2" 6-way valve/6-Wege Ventil/vanne 6-voies/valvoa a 6 vie/válvula de 6 vías	148,00





Sandfilteranlagen / Sand Filter Systems / Groupes de filtration à sable  
Grupos de filtración de arena / Gruppi filtranti a sabbia

## AZUR

### Sand Filtration Kit With ABG Pump 4-way Valve

Sandfilteranlagen mit ABG Pumpe und 4-Wege Ventil

Kit de filtration à sable avec vanne 4 voies

Gruppi filtranti con pompa ABG e valvola a 4 vie

Kit de filtración con bomba ABG válvula 4 vías

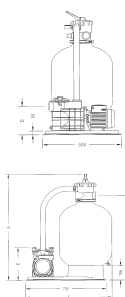

Model Modell Modèle Modello Modelo	Description Beschreibung Désignation Descrizione Descripción	List price € Listenpreis in € Prix de liste € Prezzo di listino € P.V.P. €
FS-12A4-ST25	Ø 300 mm - 5 m <sup>3</sup> /h - 0,18kW pump/pumpe/pompe/pompa/bomba	376,00
FS-15A4-ST25	Ø 380 mm - 5 m <sup>3</sup> /h - 0,18kW pump/pumpe/pompe/pompa/bomba	413,00
FS-15A4-ST31	Ø 380 mm - 5,5 m <sup>3</sup> /h - 0,25kW pump/pumpe/pompe/pompa/bomba	470,00

#### Replacement valves - Ersatzventile - Vannes de remplacement - Parti di ricambio - Válvulas de repuesto

E-27-2030	1 1/2" 4-way valve/4-Wege Ventil/vanne 4-voies/valvola a 4 vie/válvula de 4 vías	72,00
-----------	--	-------

## AZUR

### Sand Filtration Kit With ABG Pump 6-way Valve - Sandfilteranlagen mit ABG Pumpe und 6-Wege Ventil - Kit de filtration à sable avec vanne 6 voies - Gruppi filtranti con pompa ABG e valvola a 6 vie - Kit de filtración con bomba ABG válvula 6 vías

Sandfilteranlagen mit ABG Pumpe und 6-Wege Ventil - Kit de filtration à sable avec vanne 6 voies - Gruppi filtranti con pompa ABG e valvola a 6 vie - Kit de filtración con bomba ABG válvula 6 vías

Kit de filtración con bomba ABG válvula 6 vías

Model Modell Modèle Modello Modelo	Description Beschreibung Désignation Descrizione Descripción	List price € Listenpreis in € Prix de liste € Prezzo di listino € P.V.P. €
FS-15A6-ST25	Ø 380 mm - 4 m <sup>3</sup> /h - 0,18kW pump/pumpe/pompe/pompa/bomba	437,00
FS-15A6-ST31	Ø 380 mm - 5,5 m <sup>3</sup> /h - 0,25kW pump/pumpe/pompe/pompa/bomba	503,00
FS-19A6-ST51	Ø 480 mm - 7,5 m <sup>3</sup> /h - 0,37kW pump/pumpe/pompe/pompa/bomba	576,00
FS-22A6-ST71	Ø 560 mm - 10,5 m <sup>3</sup> /h - 0,55kW pump/pumpe/pompe/pompa/bomba	685,00

#### Replacement valves - Ersatzventile - Vannes de remplacement - Parti di ricambio - Válvulas de repuesto

E-27-2026	1 1/2" valve 6 positions/válvula 6 posiciones	148,00
-----------	---	--------

## SWIMMEY KIT

### Sand Filtration Kit With Swimmey pump - Sandfilteranlagen mit Swimmey Pumpe - Kit de filtration avec pompe Swimmey - Gruppi filtranti con pompa Swimmey - Kit de filtración con bomba Swimmey

Sandfilteranlagen mit Swimmey Pumpe - Kit de filtration avec pompe Swimmey - Gruppi filtranti con pompa Swimmey - Kit de filtración con bomba Swimmey

Model Modell Modèle Modello Modelo	Description Beschreibung Désignation Descrizione Descripción	List price € Listenpreis in € Prix de liste € Prezzo di listino € P.V.P. €
FS-15AZ-SW12	Ø380 - 5,5m <sup>3</sup> /h - 1/3HP*	470,00
FS-15KT-SW12	Ø380 - 5,5m <sup>3</sup> /h - 1/3HP**	503,00
FS-19AZ-SW15	Ø480 - 7,5m <sup>3</sup> /h - 1/2HP**	576,00
FS-22AZ-SW19	Ø560 - 10,5m <sup>3</sup> /h - 3/4HP**	685,00

\* incl. 4-way valve / inkl. 4-Wege Ventil / avec vanne 4-voies / Inclusa valvola a 4 vie / Incluye válvula de 4 vías

\*\* incl. 6-way valve / inkl. 6-Wege Ventil / avec vanne 6-voies / Inclusa valvola a 6 vie / Incluye válvula de 6 vías



Commercial filters / Handelsüblichen Filter / Filtres commerciaux  
Filtros comerciales / Filtri commerciali

## TRITON XL

**Working pressure: 2,5 bar - Betriebsdruck - Pression de service**  
**Pressione di esercizio - Presión de servicio**

Model Modell Modèle Modello Modelo	Flow Rates m <sup>3</sup> /h at 50 m <sup>3</sup> /h/m <sup>2</sup> Filterleistung m <sup>3</sup> /h bei 50 m <sup>3</sup> /h/m <sup>2</sup> Débit en m <sup>3</sup> /h basé sur 50 m <sup>3</sup> /h/m <sup>2</sup> Flusso max m <sup>3</sup> /h a 50 m <sup>3</sup> /h/m <sup>2</sup> Caudal máx. en m <sup>3</sup> /h a 50 m <sup>3</sup> /h/m <sup>2</sup>	Description Beschreibung Désignation Descrizione Descripción	List price € Listenpreis in € Prix de liste € Prezzo di listino € P.V.P. €
CXL-4271-25	26	Ø 1071 DN65 - 75mm	2645,00
CXL-4271-25S	26	CXL-4271-25 with 90mm sight glass - Avec hublot - con cristal de visión	2840,00
CXL-6377-25	61	Ø 1623 DN100 - 110mm	4420,00
CXL-6377-25S	61	CXL-6377-25 with 90mm sight glass - Avec hublot - con cristal de visión	4620,00
CXL-7978-25	97	Ø 2045 DN125 - 125mm	5880,00
CXL-7978-25S	97	CXL-7978-25 with 90mm sight glass - Avec hublot - con cristal de visión	6090,00

**Working pressure: 4 bar - Betriebsdruck - Pression de service**  
**Pressione di esercizio - Presión de servicio**

Model Modell Modèle Modello Modelo	Flow Rates m <sup>3</sup> /h at 50 m <sup>3</sup> /h/m <sup>2</sup> Filterleistung m <sup>3</sup> /h bei 50 m <sup>3</sup> /h/m <sup>2</sup> Débit en m <sup>3</sup> /h basé sur 50 m <sup>3</sup> /h/m <sup>2</sup> Flusso max m <sup>3</sup> /h a 50 m <sup>3</sup> /h/m <sup>2</sup> Caudal máx. en m <sup>3</sup> /h a 50 m <sup>3</sup> /h/m <sup>2</sup>	Description Beschreibung Désignation Descrizione Descripción	List price € Listenpreis in € Prix de liste € Prezzo di listino € P.V.P. €
CXL-4271-40	26	Ø 1071 DN65 - 75mm	2850,00
CXL-4271-40S	26	CXL-4271-40 with 90mm sight glass	3060,00
CXL-6377-40	61	Ø 1623 DN100 - 110mm	5140,00
CXL-6377-40S	61	CXL-6377-40 with 90mm sight glass	5380,00
CXL-7978-40	97	Ø 2045 DN125 - 125mm	6600,00
CXL-7978-40S	97	CXL-7978-40 with 90mm sight glass	6870,00





Cartridge filters / Kartuschenfilter / Filtres à cartouche  
Filtros de cartucho / Filtri a cartuccia

# CLEAN & CLEAR PLUS

Model Modell Modèle Modello Modelo	Flow Rates m <sup>3</sup> /h at 50 m <sup>3</sup> /h/m <sup>2</sup> Filterleistung m <sup>3</sup> /h bei 50 m <sup>3</sup> /h/m <sup>2</sup> Débit en m <sup>3</sup> /h basé sur 50 m <sup>3</sup> /h/m <sup>2</sup> Flusso max m <sup>3</sup> /h a 50 m <sup>3</sup> /h/m <sup>2</sup> Caudal máx. en m <sup>3</sup> /h a 50 m <sup>3</sup> /h/m <sup>2</sup>	Description Beschreibung Désignation Descrizione Descripción	List price € Listenpreis in € Prix de liste € Prezzo di listino € P.V.P. €
H-16-0310	22	Fiberglass-reinforced - resistenter Fiberglass - renforcé fibre de verre - rinforzato con fibra di vetro - reforzado con fibra de vidrio	700,00
H-16-0340	30	Fiberglass-reinforced - resistenter Fiberglass - renforcé fibre de verre - rinforzato con fibra di vetro - reforzado con fibra de vidrio	800,00
H-16-0301	39	Fiberglass-reinforced - resistenter Fiberglass - renforcé fibre de verre - rinforzato con fibra di vetro - reforzado con fibra de vidrio	900,00
H-16-0332	48	Fiberglass-reinforced - resistenter Fiberglass - renforcé fibre de verre - rinforzato con fibra di vetro - reforzado con fibra de vidrio	1 100,00







D.E. Filters / Filtres à diatomée / Filtros de diatomeas / Filtri a diatomee

## FNS PLUS

Model Modell Modèle Modello Modelo	Flow Rates m <sup>3</sup> /h at 50 m <sup>3</sup> /h/m <sup>2</sup> Filterleistung m <sup>3</sup> /h bei 50 m <sup>3</sup> /h/m <sup>2</sup> Débit en m <sup>3</sup> /h basé sur 50 m <sup>3</sup> /h/m <sup>2</sup> Flusso max m <sup>3</sup> /h a 50 m <sup>3</sup> /h/m <sup>2</sup> Caudal máx. en m <sup>3</sup> /h a 50 m <sup>3</sup> /h/m <sup>2</sup>	Description Beschreibung Désignation Descrizione Descripción	List price € Listenpreis in € Prix de liste € Prezzo di listino € P.V.P. €
H-18-0006	13	FNS plus 24	882,00
H-18-0007	20	FNS plus 36	978,00
H-18-0008	26	FNS plus 48	1 100,00
H-18-0009	33	FNS plus 60	1 213,00



## NAUTILUS

Model Modell Modèle Modello Modelo	Flow Rates m <sup>3</sup> /h at 50 m <sup>3</sup> /h/m <sup>2</sup> Filterleistung m <sup>3</sup> /h bei 50 m <sup>3</sup> /h/m <sup>2</sup> Débit en m <sup>3</sup> /h basé sur 50 m <sup>3</sup> /h/m <sup>2</sup> Flusso max m <sup>3</sup> /h a 50 m <sup>3</sup> /h/m <sup>2</sup> Caudal máx. en m <sup>3</sup> /h a 50 m <sup>3</sup> /h/m <sup>2</sup>	Description Beschreibung Désignation Descrizione Descripción	List price € Listenpreis in € Prix de liste € Prezzo di listino € P.V.P. €
H-18-0724	13	Ø 470 mm FNS 24	1 108,00
H-18-0736	20	Ø 470 mm FNS 36	1 176,00
H-18-0748	26	Ø 470 mm FNS 48	1 222,00
H-18-0760	33	Ø 470 mm FNS 60	1 343,00



## QUAD D.E.

Model Modell Modèle Modello Modelo	Flow Rates m <sup>3</sup> /h at 50 m <sup>3</sup> /h/m <sup>2</sup> Filterleistung m <sup>3</sup> /h bei 50 m <sup>3</sup> /h/m <sup>2</sup> Débit en m <sup>3</sup> /h basé sur 50 m <sup>3</sup> /h/m <sup>2</sup> Flusso max m <sup>3</sup> /h a 50 m <sup>3</sup> /h/m <sup>2</sup> Caudal máx. en m <sup>3</sup> /h a 50 m <sup>3</sup> /h/m <sup>2</sup>	Description Beschreibung Désignation Descrizione Descripción	List price € Listenpreis in € Prix de liste € Prezzo di listino € P.V.P. €
H-188592	27	QUAD D.E. 60	1 070
H-188593	36	QUAD D.E. 80	1 230



### Replacement cartridges - Ersatzkartuschen - Cartouches de remplacement - Cartucce di ricambio - Cartuchos de recambio

H-190151	Cartridges/kartuschen/cartouches/cartucce/cartuchos QUAD D.E. 60 (4 required)	132,00
H-190152	Cartridges/kartuschen/cartouches/cartucce/cartuchos QUAD D.E. 80 (4 required)	223,00

### Replacement valves - Ersatzventile - Vannes de remplacement - Parti di ricambio - Válvulas de repuesto

E-26-1071	2" valve/ventil/vannes/valvoa/válvula	168,00
-----------	---------------------------------------	--------



## Swimming Pool Pumps / Schwimmbadpumpen / Pompes pour piscine Bombas para piscinas / Pompe per piscina

### INTELLIFLO



Model Modell Modèle Modello Modelo	Flow Rates m <sup>3</sup> /h at 8 m height Leistung in m <sup>3</sup> /h bei 8 m WS Débit à 8 m hmt Flusso in m <sup>3</sup> /h a 8m prevalenza Caudal a 8 m de altura	Motor / Moteur / Motore kW	Volt / Voltage / Voltaje / Tensione	List price € Listenpreis in € Prix de liste € Prezzo di listino € P.V.P. €
P-011012	IntelliFlo	0-3,2kW	240V	2550,00

### WHISPERFLO

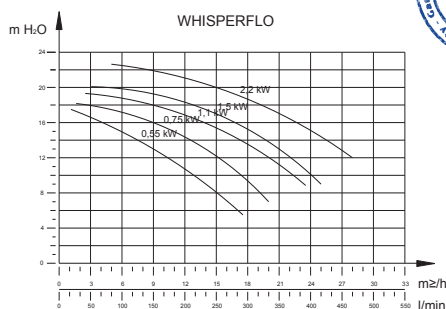

Model Modell Modèle Modello Modelo	Flow Rates m <sup>3</sup> /h at 8 m height Leistung in m <sup>3</sup> /h bei 8 m WS Débit à 8 m hmt Flusso in m <sup>3</sup> /h a 8m prevalenza Caudal a 8 m de altura	Motor / Moteur / Motore kW	Volt / Voltage / Voltaje / Tensione	List price € Listenpreis in € Prix de liste € Prezzo di listino € P.V.P. €
P-WFL-071	15	0,55kW	220-240V	523,00
P-WFL-073	15	0,55kW	380-420V	523,00
P-WFL-101	18	0,75kW	220-240V	587,00
P-WFL-103	18	0,75kW	380-420V	587,00
P-WFL-151	24	1,10kW	220-240V	646,00
P-WFL-153	24	1,10kW	380-420V	646,00
P-WFL-201	26	1,50kW	220-240V	762,00
P-WFL-203	26	1,50kW	380-420V	762,00
P-WFL-301	29	2,20kW	220-240V	950,00
P-WFL-303	29	2,20kW	380-420V	950,00

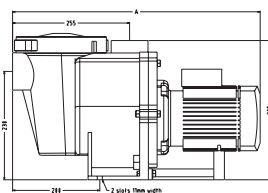



## Swimming Pool Pumps / Schwimmbadpumpen / Pompes pour piscine Bombas para piscinas / Pompe per piscina

### ULTRAFLOW



ULTRA-FLOW		Total head m H <sub>2</sub> O						
		8	10	12	14	16	18	22
Type (single/three)	Power	Flow m <sup>3</sup> /h						
P-UFL-071/073	0,55 kW	13,8	12,6	11,2	9,0	6,0		
P-UFL-101/103	0,75 kW	17,8	16,2	14,3	12,2	9,5	5,6	
P-UFL-151/153	1,1 kW		21,9	20,3	18,3	15,7	12,6	
P-UFL-201/203	1,5 kW			26,8	24,4	21,5	18,0	2,0
P-UFL-301/303	2,2 kW				28,8	26,2	22,7	14,2

at 2800 r.p.m.

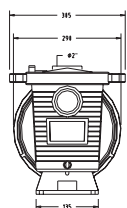
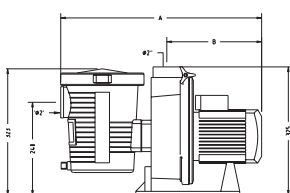

Model Modell Modèle Modello Modelo	Motor / Moteur / Motore kW	Volt / Voltage / Voltaje / Tensione	List price € Listenpreis in € Prix de liste € Prezzo di listino € P.V.P. €
P-UFL-071	0,55kW	220-240V	435,00
P-UFL-073	0,55kW	380-420V	435,00
P-UFL-101	0,75kW	220-240V	473,00
P-UFL-103	0,75kW	380-420V	473,00
P-UFL-151	1,10kW	220-240V	520,00
P-UFL-153	1,10kW	380-420V	520,00
P-UFL-201	1,50kW	220-240V	620,00
P-UFL-203	1,50kW	380-420V	620,00
P-UFL-301	2,20kW	220-240V	760,00
P-UFL-303	2,20kW	380-420V	760,00

### CHALLENGER



CHALLENGER (single/three)		Total head m H <sub>2</sub> O					
		6	9	12	15	18	21
Type	Power	Flow m <sup>3</sup> /h					
P-CHL-071/073	0,55 kW	13,5	12,0	10,0	5,0		
P-CHL-101/103	0,75 kW	16,5	15,0	12,5	8,0		
P-CHL-151/153	1,1 kW		20,0	16,5	13,0	3,0	
P-CHL-201/203	1,5 kW			23,0	20,0	15,0	
P-CHL-301/303	2,2 kW				28,0	23,0	16,0

at 2800 r.p.m.

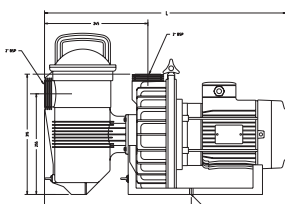

Model Modell Modèle Modello Modelo	Motor / Moteur / Motore kW	Volt / Voltage / Voltaje / Tensione	List price € Listenpreis in € Prix de liste € Prezzo di listino € P.V.P. €
P-CHL-071	0,55	220	480,00
P-CHL-073	0,55	380	480,00
P-CHL-101	0,75	220	540,00
P-CHL-103	0,75	380	540,00
P-CHL-151	1,10	220	595,00
P-CHL-153	1,10	380	595,00
P-CHL-201	1,50	220	700,00
P-CHL-203	1,50	380	700,00
P-CHL-301	2,20	220	870,00
P-CHL-303	2,20	380	870,00





Swimming Pool Pumps / Schwimmbadpumpen / Pompes pour piscine  
Bombas para piscinas / Pompe per piscina

## CHALLENGER

### BOOSTER PUMP

Model Modell Modèle Modello Modelo	Motor / Moteur / Motore kW	Volt / Voltage / Voltaje / Tensione	List price € Listenpreis in € Prix de liste € Prezzo di listino € P.V.P. €
P-CHL-B071	0,55	220	440,00
P-CHL-B073	0,55	380	440,00
P-CHL-B101	0,75	220	500,00
P-CHL-B103	0,75	380	500,00
P-CHL-B151	1,10	220	585,00
P-CHL-B153	1,10	380	585,00
P-CHL-B201	1,50	220	690,00
P-CHL-B203	1,50	380	690,00
P-CHL-B301	2,20	220	780,00
P-CHL-B303	2,20	380	780,00

## CHALLENGER

### COLLIS 2

Model Modell Modèle Modello Modelo	Motor / Moteur / Motore kW	Volt / Voltage / Voltaje / Tensione	List price € Listenpreis in € Prix de liste € Prezzo di listino € P.V.P. €
P-CHL-C071	0,55	220	365,00
P-CHL-C073	0,55	380	365,00
P-CHL-C101	0,75	220	440,00
P-CHL-C103	0,75	380	440,00
P-CHL-C151	1,10	220	535,00
P-CHL-C153	1,10	380	535,00
P-CHL-C201	1,50	220	565,00
P-CHL-C203	1,50	380	565,00
P-CHL-C301	2,20	220	695,00
P-CHL-C303	2,20	380	695,00



## Swimming Pool Pumps / Schwimmbadpumpen / Pompes pour piscine Bombas para piscinas / Pompe per piscina

### PINNACLE

PINNACLE		Total head m H.O			
		6	9	12	15
Type (single/three)	Power	Flow m <sup>3</sup> /h			
P-PIN-071/073	0,55 kW	13,0	10,0	5,5	
P-PIN-101/103	0,75 kW	16,0	13,0	8,5	3,0
P-PIN-151/153	1,1 kW	20,5	18,0	15,0	10,5

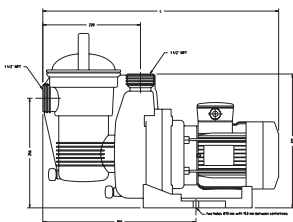

at 2800 r.p.m.



Model Modell Modèle Modello Modelo	Motor / Moteur / Motore kW	Volt / Voltage / Voltaje / Tensione	List price € Listenpreis in € Prix de liste € Prezzo di listino € P.V.P. €
P-PIN-071	0,55	220	425,00
P-PIN-073	0,55	380	425,00
P-PIN-101	0,71	220	460,00
P-PIN-103	0,71	380	460,00
P-PIN-151	1,10	220	490,00
P-PIN-153	1,10	380	490,00

### SWIMMEY

Model Modell Modèle Modello Modelo	Flow Rates m <sup>3</sup> /h at 8 m height Leistung in m <sup>3</sup> /h bei 8 m WS Débit à 8 m hmt Flusso in m <sup>3</sup> /h a 8m prevalenza Caudal a 8 m de altura	Motor / Moteur / Motore kW	Volt / Voltage / Voltaje / Tensione	List price € Listenpreis in € Prix de liste € Prezzo di listino € P.V.P. €
P7242160	7,5	0,37kW	220-240V	237,00
P7242230	7,5	0,37kW	380-420V	237,00
P7242170	10	0,50kW	220-240V	245,00
P7242240	10	0,50kW	380-420V	245,00
P7242180	14	0,75kW	220-240V	268,00
P7242250	14	0,75kW	380-420V	268,00
P7242220	15	1,00kW	220-240V	319,00
P7242260	15	1,00kW	380-420V	319,00
P7242270	20,5	1,13kW	220-240V	350,00
P7242280	20,5	1,13kW	380-420V	350,00
P7242290	24	1,50kW	220-240V	380,00
P7242300	24	1,50kW	380-420V	380,00

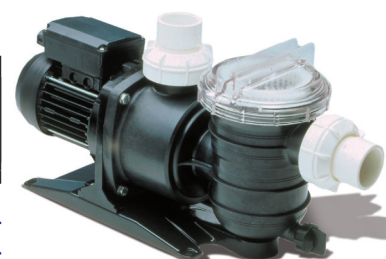

### EQ PUMPS

Model Modell Modèle Modello Modelo	Description Beschreibung Désignation Descrizione Descripción	Motor / Moteur / Motore kW	Volt / Voltage / Voltaje / Tensione	List price € Listenpreis in € Prix de liste € Prezzo di listino € P.V.P. €
P-34-0049	PUMP EQK1000 - 50Hz with strainer pot/ mit Vorfilter 6" x 4"	10	380	3 090,00
P-34-0080	PUMP EQK750 - 50Hz with strainer pot/ mit Vorfilter 6" x 4"	7.5	380	2 890,00
P-34-0081	PUMP EQK500 - 50Hz with strainer pot/ mit Vorfilter 6" x 4"	5	380	2 850,00
P-34-0082	PUMP EQK300 - 50Hz with strainer pot/ mit Vorfilter 6" x 4"	3	380	2 400,00
P-34-0083	PUMP EQK1000 - 50Hz with strainer pot/ mit Vorfilter 6" x 4"	10	380	2 650,00
P-34-0084	PUMP EQK750 - 50Hz with strainer pot/ mit Vorfilter 6" x 4"	7.5	380	2 500,00
P-34-0085	PUMP EQK500 - 50Hz with strainer pot/ mit Vorfilter 6" x 4"	5	380	2 450,00
P-34-0086	PUMP EQK300 - 50Hz with strainer pot/ mit Vorfilter 6" x 4"	3	380	1 990,00





Automatic Vacuum Pool Cleaners / Automatische Vacuum Schwimmbadreiniger  
 Nettoyeur automatique pour piscines / Pulitori automatici lato aspirazione  
 Limpiafondos automáticos de aspiración para piscinas

## E-Z Vac®

Model Modell Modèle Modello Modelo	Description Beschreibung Désignation Descrizione Descripción	List price € Listenpreis in € Prix de liste € Prezzo di listino € P.V.P. €
G-K-0015	Automatic Pool Cleaner including 12m hoses and Accessories Automatischer Schwimmbadreiniger inklusive 12m Schlauch und Zubehör Cet appareil est livré complet avec 12 m de tuyaux Pulitore automatico fornito completo dei suoi accessori e 12 m di tubo Limpiafondos automático G-K-0015 con 12m manguera y accesorios	270,00



## New Kreepy Krauly®

Model Modell Modèle Modello Modelo	Description Beschreibung Désignation Descrizione Descripción	List price € Listenpreis in € Prix de liste € Prezzo di listino € P.V.P. €
G-K-0014	Automatic Pool Cleaner including 12m hoses and Accessories Automatischer Schwimmbadreiniger inklusive 12m Schlauch und Zubehör Cet appareil est livré complet avec 12 m de tuyaux Pulitore automatico fornito completo dei suoi accessori e 12 m di tubo Limpiafondos automático new kreepy krauly con 12m maguera y accesorios	350,00



## Kreepy Kadet®

Model Modell Modèle Modello Modelo	Description Beschreibung Désignation Descrizione Descripción	List price € Listenpreis in € Prix de liste € Prezzo di listino € P.V.P. €
G-K-0013	Automatic Pool Cleaner including 12m hoses and Accessories Automatischer Schwimmbadreiniger inklusive 12m Schlauch und Zubehör Cet appareil est livré complet avec 12 m de tuyaux Pulitore automatico fornito completo dei suoi accessori e circa 12 m di tubo Limpiafondos automático kreepy kadet con apróx. 12m maguera y accesorios	320,00







Automatic Vacuum Pool Cleaners / Automatische Vacuum Schwimmbadreiniger  
 Nettoyeur automatique pour piscines / Pulitori automatici lato aspirazione  
 Limpiafondos automáticos de aspiración para piscinas

## Lil Shark

Model Modell Modèle Modello Modelo	Description Beschreibung Désignation Descrizione Descripción	List price € Listenpreis in € Prix de liste € Prezzo di listino € P.V.P. €
GW8000	The GW8000 comes fully equipped, including 10 m hose Der GW8000 ist mit ca. 10 m Schlauch und Zubehör ausgerüstet Le GW8000 est livré complet avec ses accessoires et 10 m de tuyau GW8000 fornito completo dei suoi accessori e 10 m di tubo Limpiafondos GW8000 totalmente equipado con 10m manguera	269,00



## PoolShark

Model Modell Modèle Modello Modelo	Description Beschreibung Désignation Descrizione Descripción	List price € Listenpreis in € Prix de liste € Prezzo di listino € P.V.P. €
GW7500	The GW7500 comes fully equipped, including 10,3 m hose Der GW7500 ist mit ca. 10,3 m Schlauch und Zubehör ausgerüstet Le GW7500 est livré complet avec ses accessoires et 10,3 m de tuyau GW7500 fornito completo dei suoi accessori e 10,3 m di tubo El GW7500 viene totalmente equipado con 10.3M mang. y accesorios	453,00



## Great White

Model Modell Modèle Modello Modelo	Description Beschreibung Désignation Descrizione Descripción	List price € Listenpreis in € Prix de liste € Prezzo di listino € P.V.P. €
GW9500	The GW9500 comes fully equipped, including 10 m hose Der GW9500 ist mit ca. 10 m Schlauch und Zubehör ausgerüstet Le GW9500 est livré complet avec ses accessoires et 10 m de tuyau GW9500 fornito completo dei suoi accessori e 10 m di tubo El GW9500 viene totalmente equipado con 10m mang. y accesorios	524,00





Automatic Pressure Pool Cleaners / Automatische Pool - Druckreiniger  
 Nettoyeur automatique à pression / Limpiafondos automáticos  
 a presión para piscinas / Pulitori automatici lato pressione

## Letro® LEGEND

Model Modell Modèle Modello Modelo	Description Beschreibung Désignation Descrizione Descripción	List price € Listenpreis in € Prix de liste € Prezzo di listino € P.V.P. €
--	--	--

G-L-L105G	Legend*	768,00
-----------	---------	--------

Requires additional booster pump - druckerhöhungspumpe wird gebraucht - fonctionne avec un surpresseur (non fourni) - richiede una pompa booster addizionale - requiere bomba de presión



## Letro® LEGEND II

Model Modell Modèle Modello Modelo	Description Beschreibung Désignation Descrizione Descripción	List price € Listenpreis in € Prix de liste € Prezzo di listino € P.V.P. €
--	--	--

G-L-LX2000G	Letro II	893,00
-------------	----------	--------

No booster pump required - Keine Boosterpumpe erforderlich - Aucun surpresseur nécessaire - Non occorre alcuna pompa ausiliaria - No requiere bomba de circulación



Debris channel.



Dual thrust jets for superior pool coverage.



Quad-jetted vortex venturi for superior cleaning action.

## Letro® SWEEP

Model Modell Modèle Modello Modelo	Description Beschreibung Désignation Descrizione Descripción	List price € Listenpreis in € Prix de liste € Prezzo di listino € P.V.P. €
--	--	--

G-L-L105	Legend SWEEP	679,00
----------	--------------	--------

Requires additional booster pump - druckerhöhungspumpe wird gebraucht - fonctionne avec un surpresseur (non fourni) - richiede una pompa booster addizionale - requiere bomba de presión





Electrical Pool Cleaners / Automatischer Robotreiniger  
 Robot nettoyeur de piscine / Limpiafondos automáticos  
 eléctricos para piscinas / Pulitori automatici elettrici

## KR730 ROBOT

Model Modell Modèle Modello Modelo	Description Beschreibung Désignation Descrizione Descripción	List price € Listenpreis in € Prix de liste € Prezzo di listino € P.V.P. €
H-ROBOT-2	Robot KR 730 with Remote Control and multiple programs Robot KR 730 entspr. KR 720 plus Remote Control Robot KR 730 livré complet avec telecommande et chariot (multiprogrammes) Robot KR730 con telecomando e programmi multipli Robot KR 730 con sist. aqua smart system, mando a distancia y multiples programas	3040,00

## KR720 ROBOT

Model Modell Modèle Modello Modelo	Description Beschreibung Désignation Descrizione Descripción	List price € Listenpreis in € Prix de liste € Prezzo di listino € P.V.P. €
H-ROBOT-1	Robot KR 720 with Aqua Smart System Robot KR 720 mit Aqua Smart System Robot KR 720 livré avec chariot - programme aquasmart Robot KR720 con Aqua Smart System Robot KR 720 con sist. aqua smart system para piscinas máx. 80 m²	2 200,00

## KR700 ROBOT

Model Modell Modèle Modello Modelo	Description Beschreibung Désignation Descrizione Descripción	List price € Listenpreis in € Prix de liste € Prezzo di listino € P.V.P. €
H-ROBOT-4	Robot KR 700	1 960,00







## White Goods / Kunststoffeinbauteile / Pièces à sceller Piezas A Empotrar / Materiale per interno

### Skimmers for Concrete Pools - Skimmer für Beton Becken - Skimmer pour piscines en béton - Skimmer per piscine in cemento - Skimmers para piscinas de hormigón

Model Modell Modèle Modello Modelo	Description Beschreibung Désignation Descrizione Descripción	List price € Listenpreis in € Prix de liste € Prezzo di listino € P.V.P. €
G-SKI-CSTD	Skimmer concrete standard - Standard skimmer betonbecken - Skimmer béton standard - Skimmer standard per cemento - Skimmer para piscinas de hormigón estándar	49,00
G-SKI-CWM	Skimmer concrete wide mouth - Skimmer betonbecken breite saugöffnung - Skimmer béton Skimmer bocca larga per cemento - Skimmer para piscinas de hormigón de boca ancha	63,00
G-SKI-CWMO	Skimmer concrete oval wide mouth - Skimmer Betonbecken ovale breite Saugöffnung - Skimmer béton oval - Skimmer bocca larga ovale per cemento - Skimmer para piscinas de hormigón de boca ancha ovalada	75,00

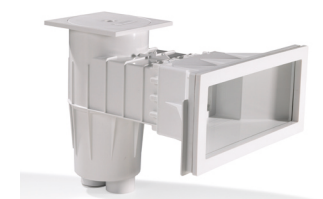

### Skimmers for Liner Pools - Skimmer für Folienbecken - Skimmer pour piscines liner - Skimmer per piscine con liner - Skimmers para piscinas revestidas

Model Modell Modèle Modello Modelo	Description Beschreibung Désignation Descrizione Descripción	List price € Listenpreis in € Prix de liste € Prezzo di listino € P.V.P. €
G-SKI-LSTD	Skimmer liner standard - Standard skimmer folienbecken Skimmer standard per liner - Skimmer para piscinas revestidas estándar	52,00
G-SKI-LWM	Skimmer liner wide mouth - Skimmer folienbecken mit breiter Saugöffnung Skimmer bocca larga per liner - Skimmer para piscinas revestidas de boca ancha	66,00
G-SKI-LWMO	Skimmer liner oval wide mouth - Skimmer folienbecken ovale breite Saugöffnung Skimmer bocca larga ovale per liner - Skimmer para piscinas revestidas de boca ancha ovalada	78,00

### Main drain with ring grate - Bodenabläufe - Bonde de fond avec grille circulaire - Presa di fondo Sumideros con anillo y rejilla

Model Modell Modèle Modello Modelo	Description Beschreibung Désignation Descrizione Descripción	List price € Listenpreis in € Prix de liste € Prezzo di listino € P.V.P. €
G-MAIN-LSTD	Main drain liner standard - Standard bodenablauf folienbecken - Bonde de fond liner standard - Presa di fondo standard per liner - Sumidero para piscinas revestidas	25,00
G-MAIN-CSTD	Main drain concrete standard - Standard bodenablauf betonbecken - Bonde de fond béton Standard - Presa di fondo standard per cemento - Sumidero para piscinas de hormigón	14,00



### Main drain with anti vortex cover - Anti-vortex bodenabläufe - Bonde de fond avec couverde anti-vortex. Presa di fondo con griglia anti vortex - Sumideros con cubierta anti vértice

Model Modell Modèle Modello Modelo	Description Beschreibung Désignation Descrizione Descripción	List price € Listenpreis in € Prix de liste € Prezzo di listino € P.V.P. €
G-MAIN-CANTV	Main drain concrete anti vortex - anti-vortex bodenablauf für betonbecken - Bonde de fond béton anti-vortex - Presa di fondo anti vortex per cemento - Sumideros con cubierta anti vértice para piscinas de hormigón	18,00
G-MAIN-LANTV	Main drain liner anti vortex - anti-vortex bodenablauf für folienbecken - Bonde de fond liner anti-vortex - Presa di fondo anti vortex per liner - Sumideros con cubierta anti vértice para piscinas revestidas	25,00





## White Goods / Kunststoffeinbauteile / Pièces à sceller Piezas A Empotrar / Materiale per interno

### Deckbox - Kabelanschlussbox - Boîtier de connection - Scatola di derivazione - Cubierta

Model	Description	List price €
Modell	Beschreibung	Listenpreis in €
Modèle	Désignation	Prix de liste €
Modello	Descrizione	Prezzo di listino €
Modelo	Descripción	P.V.P. €

G-DECKBOX-1	Deckbox / Kabelanschlussbox / Boîtier de connection / Scatola di derivazione / Cubierta	13,00
-------------	---	-------



### Wall fittings - Wanddurchführungen - Traversée de Mur - Passanti a muro - Racores pared

Model	Description	List price €
Modell	Beschreibung	Listenpreis in €
Modèle	Désignation	Prix de liste €
Modello	Descrizione	Prezzo di listino €
Modelo	Descripción	P.V.P. €

G-WALL-CLO	Wall fitting concrete 300mm - Wanddurchführung 300mm Betonbecken - traversée de paroi béton 300 mm - Passante a muro per cemento 300 mm - Racor de pared de 300 mm para piscinas de hormigón	6,00
G-WALL-CSH	Wall fitting concrete 250mm - Wanddurchführung 250mm Betonbecken - traversée de paroi béton 250 mm - Passante a muro per cemento 250 mm - Racor de pared de 250 mm para piscinas de hormigón de 300mm	6,00
G-WALL-LLO	Wall fitting liner 300mm - Wanddurchführung 300mm Folienbecken - traversée de paroi liner 300 mm - Passante a muro per liner 300 mm - Racor de pared de 300 mm para piscinas revestidas	7,00
G-WALL-LSH	Wall fitting liner 250mm - Wanddurchführung 250mm Folienbecken - traversée de paroi liner 250 mm - Passante a muro per liner 250 mm - Racor de pared de 250 mm para piscinas revestidas	7,00



### Eyeball Inlet - Regulierbare Einlaufdüse - Refoulement - Bocchetta a parete Entradas de bola direccionables

Model	Description	List price €
Modell	Beschreibung	Listenpreis in €
Modèle	Désignation	Prix de liste €
Modello	Descrizione	Prezzo di listino €
Modelo	Descripción	P.V.P. €

G-INLET-CONC	Eyeball inlet for concrete pools - Regulierbare einlaufdüse für betonbecken - refoulement béton - Bocchetta a parete per piscine in cemento - Entrada de bola direccionable para piscinas de hormigón	6,00
G-INLET-LIN	Eyeball inlet for liner pools - Regulierbare einlaufdüse für folienbecken - refoulement liner - Bocchetta a parete per piscine in liner - Entrada de bola direccionable para piscinas revestidas	18,00
G-INLET-PAN	Eyeball inlet for panel pools - Regulierbare einlaufdüse für betonbecken - refoulement pour piscine panneaux - Bocchetta a parete per piscine a pannelli - Entrada de bola direccionable para piscinas de paneles	18,00

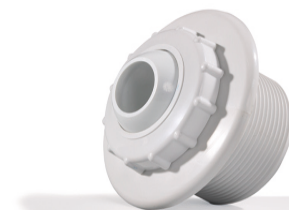



White Goods / Kunststoffeinbauteile / Pièces à sceller  
Piezas A Empotrar / Materiale per interno

## Skimmers for Above Ground Pools - Skimmer für Aufstellbecken - Skimmers pour piscine hors sol - Skimmers per piscine fuoriterra - Skimmers para piscinas elevadas

Model Modell Modèle Modello Modelo	Description Beschreibung Désignation Descrizione Descripción	List price € Listenpreis in € Prix de liste € Prezzo di listino € P.V.P. €
H-RA-P001	Standard above ground skimmer set - white Skimmer Set inklusive Einlaufdüse und Vakuumpalte - weiß Skimmer pour piscine hors sol - blanc Kit skimmer standard per piscine fuoriterra - bianco Skimmer set para piscinas elevadas estándar - blanco	25,00
H-RA-P001B	Standard above ground skimmer set - black Skimmer Set inklusive Einlaufdüse und Vakuumpalte - schwarz Skimmer pour piscine hors sol - noir Kit skimmer standard per piscine fuoriterra - nero Skimmer set para piscinas elevadas estándar - negro	25,00
H-RA-P001G	Standard above ground skimmer set - grey Skimmer Set inklusive Einlaufdüse und Vakuumpalte - grau Skimmer pour piscine hors sol - gris Kit skimmer standard per piscine fuoriterra - grigio Skimmer set para piscinas elevadas estándar - gris	57,00
H-RA-P002	Wide mouth above ground skimmer set - white Skimmer Set mit breiter Saugöffnung - weiß - Skimmer grande meutrière pour piscines hors sol - blanc - Kit skimmer bocca larga per piscine fuoriterra - bianco - Skimmer set para piscinas elevadas de boca ancha - blanco	37,00
H-RA-P002B	Wide mouth above ground skimmer set - black Skimmer Set mit breiter Saugöffnung - schwarz Skimmer grande meutrière pour piscines hors sol - noir Kit skimmer bocca larga per piscine fuoriterra - nero Skimmer set para piscinas elevadas de boca ancha - negro	37,00
H-RA-P002G	Wide mouth above ground skimmer set - grey Skimmer Set mit breiter Saugöffnung - grau Skimmer grande meutrière pour piscine hors sol - gris Kit skimmer bocca larga per piscine fuoriterra - grigio Skimmer set para piscinas elevadas de boca ancha - gris	69,00





White Goods / Kunststoffeinbauteile / Pièces à sceller  
Piezas A Empotrar / Materiale per interno

## Plastic Pool Light - Kunststoffscheinwerfer für schwimmbad - Projecteurs Fari per piscina in plastica - Cajas de plástico para la iluminación de la piscina

Model Modell Modèle Modello Modelo	Description Beschreibung Désignation Descrizione Descripción	List price € Listenpreis in € Prix de liste € Prezzo di listino € P.V.P. €
G-LIGHT-CON	300 Watt - 12 Volts plastic light for concrete pools - projecteur 300w/12V béton Faro in plastica per piscine in cemento - Caja de plástico para iluminación de piscinas de hormigón	115,00
G-LIGHT-LIN	300 Watt - 12 Volts plastic light for liner pools - projecteur 300W/12V liner - Faro in plastica per piscine con liner - Caja de plástico para de piscinas revestidas	130,00
G-LI-SNAP	(x3) Snap on multiple color filters - Lentilles de couleur - Lenti colorate - Filtro/Revestimiento	20,00



## Transformers for swimming-pool lights - Transformatoren für Schwimmbadleuchten Transformateurs pour projecteurs de piscine - Trasformatori per fari da piscina - Transformadores para la iluminación de piscinas

Model Modell Modèle Modello Modelo	Description Beschreibung Désignation Descrizione Descripción	List price € Listenpreis in € Prix de liste € Prezzo di listino € P.V.P. €
05278-0100	Safety isolating transformer - Sicherheitstransformator - Transformateur isolé - Trasformatore di sicurezza isolante - Transformador de seguridad aislante 12 Volt 100VA 2 x 50 VA	70,00
05278-0150	Safety isolating transformer - Sicherheitstransformator - Transformateur isolé - Trasformatore di sicurezza isolante - Transformador de seguridad aislante 12 Volt 150VA 2 x 75 VA	82,60
05278-0300	Safety isolating transformer - Sicherheitstransformator - Transformateur isolé - Trasformatore di sicurezza isolante - Transformador de seguridad aislante 12 Volt 300VA 1 x 300 VA	115,00
05278-0600	Safety isolating transformer - Sicherheitstransformator - Transformateur isolé - Trasformatore di sicurezza isolante - Transformador de seguridad aislante 12 Volt 600VA 2 x 300 VA	153,60
05278-0900	Safety isolating transformer - Sicherheitstransformator - Transformateur isolé - Trasformatore di sicurezza isolante - Transformador de seguridad aislante 12 Volt 900VA 3 x 300 VA	212,10
G-EVGM-300	Multi-trap transformer - Multi trasformatore - Transformador multi-atrape 300w, 12v - 13v -14v	231,00





## Underwaterlights / Unterwasserscheinwerfer Eclairage subaquatique / Iluminación acuática / Fari per piscina

### SAM

#### Underwaterlight multi color - Unterwasserscheinwerfer farbig Eclairage subaquatique multi-couleur - Faro multicolore - Luces acuáticas multicolor

Model Modell Modèle Modello Modelo	Description Beschreibung Désignation Descrizione Descripción	List price € Listenpreis in € Prix de liste € Prezzo di listino € P.V.P. €
H-60-0049	SAM 12V - Cord length - Kabellänge - Longueur de câble - Lunghezza cavo - con cable 5 m (15')	802,00
H-60-0050	SAM 12V - Cord length - Kabellänge - Longueur de câble - Lunghezza cavo - con cable 15 m (50')	845,00

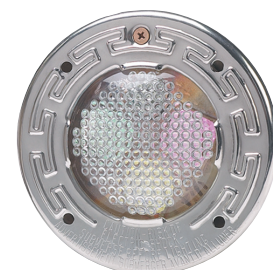

#### Niches for concrete pools - Einbaunischen für beton-becken - Niches SAM pour piscines Béton - Nicchie per piscine in cemento - Nichos para piscinas de hormigón

Model Modell Modèle Modello Modelo	Description Beschreibung Désignation Descrizione Descripción	List price € Listenpreis in € Prix de liste € Prezzo di listino € P.V.P. €
H-78210400	Stainless steel niche 3/4" - Edelstahl-Einbaunische mit seitlicher 3/4" Muffe Niche pour SAM en inox - Nicchia in acciaio 3/4" - Nicho empotrado ac. inox. con nodo lateral 3/4"	82,60
H-79206700	PVC niche 3/4" - Große PVC - Einbaunische - Niche pour SAM en PVC - Nicchia in PVC - Nicho grande empotrado de PVC 3/4"	63,00

#### Niches for vinyl & fiberglass pools - Einbaunischen für folien und GfK-Becken - Niches SAM pour piscines liner - Nicchie per piscine in vinile o fibra di vetro - Nichos para piscinas revestidas (fibra de vidrio o vinilo)

Model Modell Modèle Modello Modelo	Description Beschreibung Désignation Descrizione Descripción	List price € Listenpreis in € Prix de liste € Prezzo di listino € P.V.P. €
H-78232400	Stainless steel niche 3/4" - Edelstahl-Einbaunische mit seitlicher 3/4" Muffe Niche SAM pour piscine liner - Nicchia in acciaio inossidabile 3/4" - Nicho empotrado ac. inox. con nodo lateral 3/4"	169,55
H-62-0004	Quick niche PVC 3/4" (also for panel pools) - PVC Quick Nische für Folien und Stahlwandbecken - Niche pour SAM pour piscine liner - Nicchia rapida PVC 3/4" (anche per piscine a pannelli) - Nicho empotrado rápido de plástico (también para piscinas de paneles)	170,90

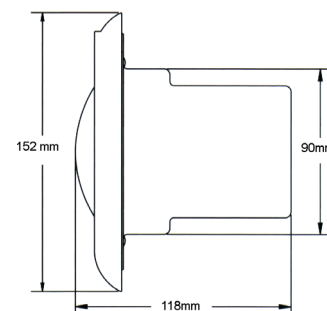

#### Accessories - Verbindung zum Anschlusskasten - Accessoires - Accessori Accesorios para la caja de conexiones

Model Modell Modèle Modello Modelo	Description Beschreibung Désignation Descrizione Descripción	List price € Listenpreis in € Prix de liste € Prezzo di listino € P.V.P. €
H-NICHE-CON	Flexible hose 1,5 m with 3/4" THD - Flexibler schlauch 1,5m mit 3/4" gewinde Adaptateur pour niche SAM - Tubo flessibile da 1,5m 3/4" - Manguera de conexion flexible 1.5m con rosca 3/4" para cajas empotradas de ac. inox.	10,60
H-NICHE-AD	3/4" adaptor for PVC niche - 3/4"-Adapter für Plastik-Einbaunische - Adaptateur pour niche SAM adattatore 3/4" per nicchia in PVC - Manguera de conexion flexible 1.5m con rosca 3/4" para cajas empotradas de PVC	5,90
H-79112400	Replacement bulb 75 Watt, 12V (2 pcs required) - Ersatzglühbirne 75 Watt 12V (2 Stück je Strahler notwendig) - Ampoule de rechange pour projecteur SAM - Bulbo di ricambio da 75W, 12V (necessari 2 pezzi) - Bombilla de repuesto 75 Watt, 12V (2 unidades requeridas)	19,10





## Underwaterlights / Unterwasserscheinwerfer Eclairage subaquatique / Iluminación acuática / Fari per piscina

### SAL

#### Underwaterlight multi color - Unterwasserscheinwerfer farbig Eclairage subaquatique mutli-couleur - Faro multicolore - Luces acuáticas multicolor

Model Modell Modèle Modello Modelo	Description Beschreibung Désignation Descrizione Descripción	List price € Listenpreis in € Prix de liste € Prezzo di listino € P.V.P. €
H-64-0011	SAL 12V - Cord length - Kabellänge - Longueur de câble - Lunghezza cavo - con cable 5 m (15')	640,00
H-64-0012	SAL 12V - Cord length - Kabellänge - Longueur de câble - Lunghezza cavo - con cable 15 m (50')	682,00

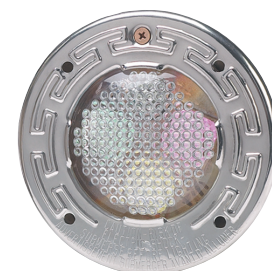

#### Niches for Concrete Spas - Einbaunischen für Becken oder Wellness-Bäder aus Beton - Nicchie per idromassaggio in cemento - Nichos para Spas de hormigón

Model Modell Modèle Modello Modelo	Description Beschreibung Désignation Descrizione Descripción	List price € Listenpreis in € Prix de liste € Prezzo di listino € P.V.P. €
H-78243200	Stainless steel niche with 3/4" top hub - Edelstahl-Einbaunische mit oberseitiger 3/4" Muffe - Niche pour SAL en inox - Nicho empotrado ac. inox c/ nodo sup. 3/4"	71,00
H-79206600	PVC SAL niche - Kleine PVC - Einbaunische - Niche pour SAL en PVC - Nicho empotrado pequeño de PVC	54,00

#### Niches for glassfiber Spas - Einbaunischen für handgefertigte Schwimmbecken und ellnessbäder aus GfK - Niche pour Spa en fibre de verre - Nicchie per idromassaggio in fibra di vetro - Nichos para Spas fabricados en fibra de vidrio

Model Modell Modèle Modello Modelo	Description Beschreibung Désignation Descrizione Descripción	List price € Listenpreis in € Prix de liste € Prezzo di listino € P.V.P. €
H-78242200	Stainless steel niche with 3/4" top hub - Edelstahl-Einbaunische mit oberseitiger 3/4" Muffe - Niche pour SAL en inox - Nicho de ac. inox. c/ nod sup. 3/4"	102,00

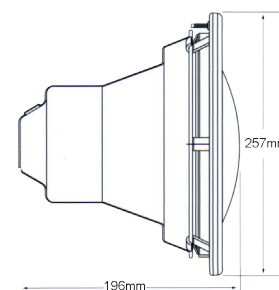

#### Accessories - Verbindung zum Anschlusskasten - Accessoires - Accessori Accesorios para la caja de conexiones

Model Modell Modèle Modello Modelo	Description Beschreibung Désignation Descrizione Descripción	List price € Listenpreis in € Prix de liste € Prezzo di listino € P.V.P. €
H-NICHE-CON	Flexible hose 1,5 m with 3/4" THD - Flexibler schlauch 1,5m mit 3/4" gewinde Adaptateur pour niche SAL - Tubo flessibile da 1,5m 3/4" - Manguera de conexion flexible 1.5m con rosca 3/4" para cajas empotradas de ac. inox.	11,00
H-NICHE-AD	3/4" adaptor for PVC niche - 3/4"-Adapter für Plastik-Einbaunische - Adaptateur pour niche SAL - Adattatore 3/4" per nicchia in PVC - Manguera de conexion flexible 1.5m con rosca 3/4" para cajas empotradas de PVC	6,00
H-650036	Replacement Bulb MR8, 35Watt, 12V (1 pcs required) - Ersatzglühbirne MR8, 35Watt 12V (1 Stück je Strahler notwendig) - Ampoule de rechange pour projecteur SAL - Bombilla de repuesto MR8, 35Watt, 12V (1 ud. requerida)	45,00
H-650037	Replacement Bulb MR11 FTF, 35Watt, 12V (3 pcs required) - Ersatzglühbirne MR11 FTF, 35Watt 12V (3 Stück je Strahler notwendig) - Ampoule de rechange pour projecteur SAL - Bombilla de repuesto MR11, 35Watt, 12V (3 uds. requeridas)	18,00





Underwaterlights / Unterwasserscheinwerfer  
Eclairage subaquatique / Iluminación acuática / Fari per piscina

Amerlite®

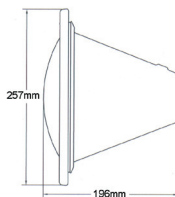

Model Modell Modèle Modello Modelo	Description Beschreibung Désignation Descrizione Descripción	List price € Listenpreis in € Prix de liste € Prezzo di listino € P.V.P. €
H-78431100	12V - 300W - Cord length - Kabellänge - Longueur de câble - Lunghezza cavo - con cable 5 m (15')	240,00
H-78438100	12V - 300W - Cord length - Kabellänge - Longueur de câble - Lunghezza cavo - con cable 15 m (50')	325,00



AquaLuminator®



Light and water return for aboveground pools - Unterwasserstrahler  
und Wasserrücklauf für Aufstellbecken - Eclairage pour piscine hors sol - Faro con  
bocchetta di ritorno per piscine fuoriterra - Luz y retorno de agua para piscinas elevadas

Model Modell Modèle Modello Modelo	Description Beschreibung Désignation Descrizione Descripción	List price € Listenpreis in € Prix de liste € Prezzo di listino € P.V.P. €
H-98600008	AquaLuminator® 240V 12V 50H incl. Transformer - inklusive Transformator Incl. transformateur - Incluso trasformatore - inc transformador	255,00
H-79100000	Fountain Attachment - Anbaufontäne - Accroche fontaine Adattatore per fontana - Fijación sin surtidor	38,00



AquaLuminator®



Replacement parts - Ersatzteile - Pièces de rechange - Parti di ricambio -  
Piezas de recambio

Model Modell Modèle Modello Modelo	Description Beschreibung Désignation Descrizione Descripción	List price € Listenpreis in € Prix de liste € Prezzo di listino € P.V.P. €
H-69100000	Replacement Bulb with clear lens - Ersatzglühbirne mit klarer Linse Ampoule de rechange - Bulbo di ricambio con lenti chiare	50,90
H-61-9364	Transformer - Transformator - Transformateur- Trasformatore - Transformador 240V/12V - 50 Hz	223,50





### Automatic Chlorine/Bromine Feeders

Automatische Chlor-/Bromdosierer

Doseurs de chlore/Brome

Dosatori automatici Cloro/Bromo a lambimento

Dosificador automático CL/Bromo

### In-Line Feeder for above ground pools - In-line Dosierer für

Aufbaubecken - Doseur in-line pour piscine hors-sol - Osatori in-line per piscine

fuoriterra - Dosificador en línea para piscinas elevadas



Model Modell Modèle Modello Modelo	Description Beschreibung Désignation Descrizione Descripción	Quantity per case Bestellmenge Conditionnement Quantità per caso Cantidad por caja	List price € Listenpreis in € Prix de liste € Prezzo di listino€ P.V.P. €
H-RA-171098EC	See through Chlorine Feeder - Durchsichtlicher Chlordosierer Doseur de chlore transparent - Dosatore di cloro versione trasparente Dosificador CL transparente #330C	6	136,00

### Off-Line Feeders - Off-Line Dosierer - Doseurs connection en parallèle

Dosatori off-line - Dosificador fuera de línea

Model Modell Modèle Modello Modelo	Description Beschreibung Désignation Descrizione Descripción	Quantity per case Bestellmenge Conditionnement Quantità per caso Cantidad por caja	List price € Listenpreis in € Prix de liste € Prezzo di listino€ P.V.P. €
H-RAK171016E	Chlorine Feeder - Chlor Dosierer - Doseur de chlore - Dosatore di cloro - Dosificador CL #300	6	87,00
H-RAK171016EC	Chlor Feeder see trough version - Chlor-Dosierer - Klarsicht-Version Doseur de chlore transparent - Dosatore di cloro versione trasparente Dosificador CL #300 transparente	6	105,00

### In-Line Feeders - In-Line Dosierer - Doseurs connection en série -

Dosatori in-line - Dosificadores en línea

Model Modell Modèle Modello Modelo	Description Beschreibung Désignation Descrizione Descripción	Quantity per case Bestellmenge Conditionnement Quantità per caso Cantidad por caja	List price € Listenpreis in € Prix de liste € Prezzo di listino€ P.V.P. €
H-RAK171096E	Chlorine Feeder - Chlor Dosierer - Dosatore di cloro Doseur de chlore - Dosificador CL #300	6	101,00
H-RAK171096EC	See through Chlorine Feeder - Chlor-Dosierer - Klarsicht-Version Doseur de chlore transparent - Dosatore di cloro versione trasparente Dosificador CL #300 transparente	6	108,00



H-RA-K171086

### Commercial Feeders - Hochleistungsdosierer - Doseurs commerciaux

Dosatori alta capacità - Dosificadores comerciales

Model Modell Modèle Modello Modelo	Description Beschreibung Désignation Descrizione Descripción	Quantity per case Bestellmenge Conditionnement Quantità per caso Cantidad por caja	List price € Listenpreis in € Prix de liste € Prezzo di listino€ P.V.P. €
H-RA-171056E	Chlorine Feeder - Chlor-Dosierer - Doseur de chlore - Dosatore di cloro - Dosificador CL #300-19 Off-line	1	94,00
H-RA-171066E	Chlorine Feeder - Chlor-Dosierer - Doseur de chlore - Dosatore di cloro - Dosificador CL #300-29 Off-line	1	100,00
H-RA-171070E	Chlorine Feeder - Chlor-Dosierer - Doseur de chlore - Dosatore di cloro - Dosificador CL #300-29X Off-line	1	131,00
H-RA-171215E	Chlor/Brom - Feeder - Dosierer - Doseur - Dosatore - Dosificador #HC3315	1	207,00
H-RA-171230E	Chlor/Brom - Feeder - Dosierer - Doseur - Dosatore - Dosificador #HC3330	1	223,00
H-RA-171240E	Chlor/Brom - Feeder - Dosierer - Doseur - Dosatore - Dosificador #HC3340	1	233,00





Salt chlorinators / Salz Chlorinator / Chlorinateurs de sel  
Generatori di cloro a sale / Cloradores salinos

## INTELLICHLOR

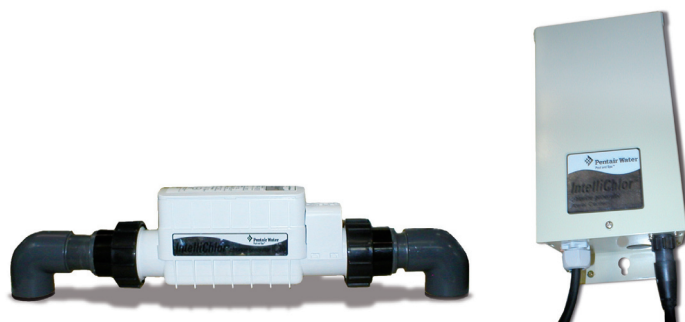

Model Modèle Modell Modello Modelo	Description Désignation Beschreibung Descrizione Descripción	List price € Prix de liste € Listenpreis in € Prezzo di listino € P.V.P. €
H-520554C	INTELLICHLOR IC20 for pools - per piscine fino - für Schwimmbad von - pour piscine de - para piscinas <b>80m<sup>3</sup></b>	1610,00
H-520555C	INTELLICHLOR IC40 for pools - für Schwimmbad von - pour piscine de - per piscine fino - para piscinas <b>150m<sup>3</sup></b>	1880,00
H-520594	INTELLICHLOR Diagnostic wand - Lecteur optique - Penna ottica per diagnostica - lápiz de diagnóstico	175,00

## AQUABLUE



Model Modèle Modell Modello Modelo	Description Désignation Beschreibung Descrizione Descripción	List price € Prix de liste € Listenpreis in € Prezzo di listino € P.V.P. €
H-SALTCHL100	SCC25 for pools - für Schwimmbad von - pour piscine de - per piscine fino a - para piscinas de <b>100 m<sup>3</sup></b>	1375,00
H-SALTCHL150	SCC40 for pools - für Schwimmbad von - pour piscine de - per piscine fino a - para piscinas de <b>150 m<sup>3</sup></b>	1530,00



## Dosing & Measuring Equipment / Dosiersysteme und Messgeräte Equipement de mesure et de dosage / Sistemi di dosaggio e misurazione Equipos de dosificación y medición

### pH & ORP

#### pH/Redox Dosing systems - pH/Redox Dosiersysteme - Système de dosage pH/Redox - Sistemi di dosaggio pH/Redox - Sistema de dosificación pH/Redox

Model Modèle Modell Modello Modelo	Description Désignation Beschreibung Descrizione Descripción	List price € Prix de liste € Listenpreis in € Prezzo di listino € P.V.P. €
H-DOS-PH	pH Dosing system with peristaltic pump - pH Dosier-System mit peristaltischer Dosierpumpe - système de dosage pH avec pompe péristaltique - Sistema di dosaggio pH con pompa peristaltica - Sistema de dosificación pH con bomba peristáltica	620,00
H-DOS-PHRD	pH/Redox Dosier-System mit peristaltischen Dosierpumpen - pH/Redox dosing system with peristaltic pump - système de dosage pH/Redox avec pompe péristaltique - sistema di dosaggio pH/Redox con pompa peristaltica - Sistema de dosificación pH/Redox con bomba peristáltica	1380,00



#### Photometer - fotometer - photomètre - fotometri - fotómetro

Model Modèle Modell Modello Modelo	Description Désignation Beschreibung Descrizione Descripción	List price € Prix de liste € Listenpreis in € Prezzo di listino € P.V.P. €
H-PHOTOM-1	Photometer for pH (Acidity), TA (Total Alkalinity), FAC (free available chlorine) - pH-Messung, Alkalinität und verfügbares freies - Photomètre pour pH (Acidité), TA (Alcalinité) et Chlor libre - Fotometro per pH (acidità) TA (alcalinità totale), FAC (cloro libero) - Comprobador para pH (Acidez), TA (Alcalinidad Total) y CL (Cloro)	171,00



#### Replacement parts - Ersatzteile - Pièces de rechange - Repuestos

Model Modèle Modell Modello Modelo	Description Désignation Beschreibung Descrizione Descripción	List price € Prix de liste € Listenpreis in € Prezzo di listino € P.V.P. €
H-PHOTOM-TAB	Tablet refill (40 tab DPD1 + 40 tab PH + 10 tab TA) - Ersatztabletten (40 Tabl. DPD1, 40 Tabl. PH und 10 Tabl. Alkalinität) - Tablettes de remplacement (40 tab DPD1 + 40 tab pH + 10 tab alcalinité) Ricarica pastiglie (40 pastiglie DPD1 + 40 past PH + 10 past. TA) - Tabletas de repuesto (40 tab DPD1 + 40 tab PH - 10 tab TA)	13,00
H-PHOTOM-TA	Refill Pack Total Alkalinity (250 tablets) - Ersatztabletten Alkalinität (250 Tabletten) Pack de remplacement des tablettes d'alcalinité (250 tablettes) - Pacco ricarica alcalinità totale (250 pastiglie) - Pack de repuesto Total Alcalinidad (250 tabletas)	89,00
H-PHOTOM-PH	Refill Pack Ph Phenol red (250 tablets) - Ersatztabletten PH Phenol Rot (250 Tabletten) Pack de recharge pH Phenol rouge (250 tablettes) - Pacco ricarica pH fenolo rosso (250 pastiglie) - Pack de repuesto Ph (250 tabletas)	31,00
H-PHOTOM-DPD1	Ersatztabletten DPD 1 (250 Tabletten) - Refill Pack DPD 1 (250 tablets) Pack de recharge DPD1 (250 tablettes) - Pacco ricarica DPD (250 pastiglie) - Pack de repuesto DPD1 (250 tabletas)	31,00
H-PHOTOM-TUB	Replacement test tubes (5 tubes per box) - Ersatz-Teströhrchen (5 Röhrchen per Schachtel) - Remplacement des tubes tests (5 tubes par boîte) - Confezione 5 provette di ricambio - Tubos de pruebas de repuesto (5 tubos por caja)	21,00



Heating Equipment / Heizungen / Chauffage  
Sistemi di riscaldamento / Equipos de calefacción

## HEATING

### Electrical pool heaters - Elektrische Heizungen für schwimmbäder Chauffages électriques pour piscine - Riscaldatori elettrici - Calentadores eléctricos

Model Modèle Modell Modello Modelo	Description Désignation Beschreibung Descrizione Descripción	List price € Prix de liste € Listenpreis in € Prezzo di listino € P.V.P. €
H-P-HEAT-3PM	3kW 220-240 Volt PE Kunststoff - Volt (mono phase) PE plastic black - Pe plastique noir - Voltios (monofase) PE plástico negro	284,00
H-P-HEAT-3PT	3kW 380-420 Volt PE Kunststoff - Volt (tri phase) PE plastic black Pe plastic black - Voltios (trifase) PE plástico negro	284,00
H-P-HEAT-6PM	6kW 220-240 Volt PE Kunststoff - Volt (mono phase) PE plastic black Pe plastic black - Voltios (monofase) PE plástico negro	290,00
H-P-HEAT-6PT	6kW 380-420 Volt PE Kunststoff - Volt (tri phase) PE plastic black Pe plastic black - Voltios (trifase) PE plástico negro	290,00
H-P-HEAT-9PT	9kW 380-420 Volt PE Kunststoff - Volt (tri phase) PE plastic black Pe plastic black - Voltios (trifase) PE plástico negro	290,00
H-P-HEAT-12PT	12kW 380-420 Volt PE Kunststoff - Volt (tri phase) PE plastic black Pe plastic black - Voltios (trifase) PE plástico negro	310,00
H-P-HEAT-15PT	15kW 380-420 Volt PE Kunststoff - Volt (tri phase) PE plastic black Pe plastic black - Voltios (trifase) PE plástico negro	315,00
H-P-HEAT-18PT	18kW 380-420 Volt PE Kunststoff - Volt (tri phase) PE plastic black Pe plastic black - Voltios (trifase) PE plástico negro	325,00

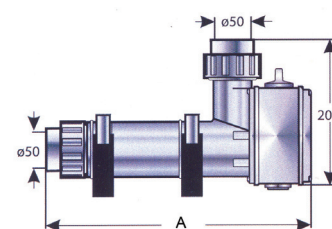
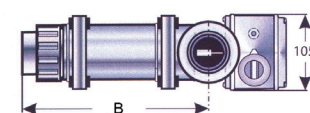

### Heat Exchangers - Wärmetauscher - Echangeurs de chaleur - Scambiatori di calore - Intercambiadores de calor

Model Modèle Modell Modello Modelo	Description Désignation Beschreibung Descrizione Descripción	List price € Prix de liste € Listenpreis in € Prezzo di listino € P.V.P. €
H-P-EXCH40	40kW PP Plastic, Nic-Tec black - PP plástico, Nic-Tec Negro	397,00
H-P-EXCH75	75kW PP Plastic, Nic-Tec black - PP plástico, Nic-Tec Negro	760,00





## Gegenstromschwimmanlage / Counter-Current Swimming Systems Système de nage à contre-courant / Sistemi di nuoto controcorrente Sistemas de natación contracorriente

### TRITON JET

Model Modèle Modell Modello Modelo	Description Désignation Beschreibung Descrizione Descripción	List price € Prix de liste € Listenpreis in € Prezzo di listino € P.V.P. €
P-JET-60	Triton Jet 60 m <sup>3</sup> /h	225,00
P-JET-70	Triton Jet 70 m <sup>3</sup> /h	227,00

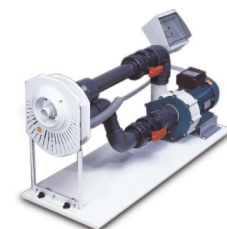

### SYSTEM 1200

Model Modèle Modell Modello Modelo	Description Désignation Beschreibung Descrizione Descripción	List price € Prix de liste € Listenpreis in € Prezzo di listino € P.V.P. €
H-P-JFRONT3	Jet Swim 1200 Front plate 2,2 kW - Frontplatte - Façade Piastra frontale - Parte frontal	755,00
H-P-JPUMP-30	Jet Swim 1200 Pump, 2,2 kW, black colour - Pumpe schwarz Pompe noire - Pompa colore nero - Bomba color negro	1 975,00
H-P-JLIN3	Jet Swim 1200 Assembly kit for Panel pools with liner - Einbaukit für Folienbecken - Pièce à sceller pour piscine panneaux/liner - Kit assemblaggio per piscine a pannelli con liner - Kit de montaje para piscinas revestidas	262,00
H-P-JCON3	Jet Swim 1200 Assembly kit for Concrete - Einbaukit für Betonbecken Pièce à sceller pour piscine béton - Kit assemblaggio per piscine in cemento Kit de montaje para piscinas de hormigón	262,00
H-P-JCONLIN3	Jet Swim 1200 Assembly kit for Concrete/Liner pools - Einbaukit für Betonbecken mit Folienauskleidung- Pièce à sceller pour piscine pour piscine béton/Liner Kit assemblaggio per piscine cemento/line - Kit de montaje para piscinas de hormigón/ revestidas	398,00



### SYSTEM 2000

Model Modèle Modell Modello Modelo	Description Désignation Beschreibung Descrizione Descripción	List price € Prix de liste € Listenpreis in € Prezzo di listino € P.V.P. €
H-P-JFRONT5	Jet Swim 2000 Front plate 4kW - Frontplatte Façade - Piastra frontale - Parte frontal	1 300,00
H-P-JPUMP-55	Jet Swim 2000 Pump, 4kW, black colour - Pumpe schwarz Pompe noire - Pompa colore nero - Bomba color negro	2 335,00
H-P-JLIN5	Jet Swim 2000 Assembly kit for Panel pools with liner - Einbaukit für Folienbecken - Pièce à sceller pour piscine panneaux/liner - Kit assemblaggio per piscine a pannelli con liner - Kit de montaje para piscinas revestidas	303,00
H-P-JCON5	Jet Swim 2000 Assembly kit for Concrete - Einbaukit für Betonbecken Pièce à sceller pour piscine béton - Kit assemblaggio per piscine in cemento Kit de montaje para piscinas de hormigón	303,00
H-P-JCONLIN5	Jet Swim 2000 Assembly kit for Concrete/Liner - Einbaukit für Betonbecken mit Folienauskleidung- Pièce à sceller pour piscine pour piscine béton/Liner Kit assemblaggio per piscine cemento/line - Kit de montaje para piscinas de hormigón/ revestidas	439,00







## Maintenance accessories / Zubehör Matériel d'entretien / Accessori / Accesorios

### Leaf Traps - Laubfang - Piège à feuilles - Atrapahojas - Atrapahojas

Model Modell Modèle Modello Modelo	Description Beschreibung Désignation Descrizione Descripción	Quantity per case Bestellmenge Conditionnement Quantità per caso Cantidad por caja	List price € Listenpreis in € Prix de liste € Prezzo di listino € P.V.P. €
--	--	--	--

H-RA-211084	Transparenter Laubfang mit Schnappverschluss, inklusive Schmutzsack aus Polyester und 1,2m 38mm Saugschlauch, Anschlüsse für 38mm Saugschlauch / 1 1/2" Snap open Leaf - Trap with debris bag #186A - atrapahojas 1/2" transparente con apertura y bolsa de residuos - Piège à feuilles transparent avec une fermeture à clapet, sac à saletés en Polyester et tuyau d'aspiration de 1,20m / 38mm. Raccords au tuyau d'aspiration de 38mm	6	90,00
-------------	---	---	-------



### Floating Dispensers - Schwimmende Chlordosierer - Doseur de chlore flottant

#### Dosatori galleggianti - Dispensadores flotantes

Model Modell Modèle Modello Modelo	Description Beschreibung Désignation Descrizione Descripción	Quantity per case Bestellmenge Conditionnement Quantità per caso Cantidad por caja	List price € Listenpreis in € Prix de liste € Prezzo di listino € P.V.P. €
--	--	--	--

H-RA-171060	Dosierschwimmer mit Schutzschirm #330 / Dispenser Floating #330 with Screen - doseur flottant avec écran - Dispensador #330 c/rejilla protectora	12	12,00
H-RA-171130	Dosierschwimmer für Aufstellbecken #332 / Dispenser Floating for above ground pools #332 / doseur flottant pour piscines hors-sol Dosatore galleggiante #330 con screen / Dosatore galleggiante per piscine fuoriterra #332 / Dispensador flotante #332 para piscinas elevadas	12	9,00



### SKIMMERS / LEAF RAKES (Service Pro)

Model Modell Modèle Modello Modelo	Description Beschreibung Désignation Descrizione Descripción	Quantity per case Bestellmenge Conditionnement Quantità per caso Cantidad por caja	List price € Listenpreis in € Prix de liste € Prezzo di listino € P.V.P. €
--	--	--	--

H-RA-K121196	Heavy Duty Skimmer.	12	8.00
H-RA-121216	Skimmer Replacement frame and net. For 126	12	5.00
H-RA-K121230	Pro Leaf Rake.	12	20.00
H-RA-121232	Pro Leaf Rake Replacement Frame and Squeegee	12	21.00



### TELESCOPIC POLES - (Service Pro)

Model Modell Modèle Modello Modelo	Description Beschreibung Désignation Descrizione Descripción	Quantity per case Bestellmenge Conditionnement Quantità per caso Cantidad por caja	List price € Listenpreis in € Prix de liste € Prezzo di listino € P.V.P. €
--	--	--	--

H-RA-191101	Extends to 6.7m (22') length	6	108.00
H-RA-191092	Extends to 4.9m (16') length	6	70.00
H-RA-191091	Extends to 3.7m (12') length	6	55.00
H-RA-191104	4.9m (16') Straight	3	60.00
H-RA-191095	3.7m (12') Straight	6	60.00
H-RA-191102	Adapt-a-Pole Kit	3	84.00
H-RA-32031	2.44m (8') Extension	bulk	25.00
H-RA-07023	Replacement tip for Fiberglass Poles	bulk	6.00
H-RA-191102	Adapt-a-Pole Kit	3	84.00
H-RA-32031	2.44m (8') Extension	bulk	25.00
H-RA-32033	Pole Adapter Sleeve	bulk	6.00
H-RA-191090	2 piece Aluminum. Metal Cam. Extends to 7.2m (23 1/2')	12	65.00
H-RA-191088	2 piece Aluminum. E-Z Lock. Extends to 23 1/2'	12	65.00





## Maintenance accessories / Zubehör Matériel d'entretien / Accessori / Accesorios

### MINI LAB TEST KIT (Service Pro)

Model Modell Modèle Modello Modelo	Description Beschreibung Désignation Descrizione Descripción	Quantity per case Bestellmenge Conditionnement Quantità per caso Cantidad por caja	List price € Listenpreis in € Prix de liste € Prezzo di listino€ P.V.P. €
H-RA-151716	Mini Lab. Red Tote Box. Includes Free, Total and Combined Chlorine, Bromine, Iodine, pH, Acid Demand, Alkali Demand, Total Alkalinity, Water Hardness and Cyanuric Acid. Cl range to 10ppm. Pro test cell with all tablets and reagents and water test booklet.	6	55.00



### PRO-VAC® (Service Pro)

Model Modell Modèle Modello Modelo	Description Beschreibung Désignation Descrizione Descripción	Quantity per case Bestellmenge Conditionnement Quantità per caso Cantidad por caja	List price € Listenpreis in € Prix de liste € Prezzo di listino€ P.V.P. €
H-RA-K201276	355 mm (14") Width. 8 Wheels	6	60.00
H-RA-K201286	559 mm (22") Width. 12 Wheels	1	70.00
H-RA-201296	737 mm (29") Width. 16 Wheels	1	135.00



### COMMERCIAL VACUUM HEADS

Model Modell Modèle Modello Modelo	Description Beschreibung Désignation Descrizione Descripción	Quantity per case Bestellmenge Conditionnement Quantità per caso Cantidad por caja	List price € Listenpreis in € Prix de liste € Prezzo di listino€ P.V.P. €
H-RA-201126	Swivel Wheel Vacuum Head. 482mm (19")	4	112.00



### Super Pro Vac

Model Modell Modèle Modello Modelo	Description Beschreibung Désignation Descrizione Descripción	Quantity per case Bestellmenge Conditionnement Quantità per caso Cantidad por caja	List price € Listenpreis in € Prix de liste € Prezzo di listino€ P.V.P. €
H-RA-201298	1041mm (41") width vacuum features ProVac technology, 22 ball bearing polyurethane adjustable wheels, dual manifold with handle joining assemble. Includes adapters for 1 1/2" or 2" vac hose	1	310.00



### Brushes (Classic Range)

Model Modell Modèle Modello Modelo	Description Beschreibung Désignation Descrizione Descripción	Quantity per case Bestellmenge Conditionnement Quantità per caso Cantidad por caja	List price € Listenpreis in € Prix de liste € Prezzo di listino€ P.V.P. €
H-RA-K111316	457mm (18") Aluminum Back. UV Stabilized Poly Bristles	Pack 12	10.00
H-RA-K500013	457mm (18") Molded Back. Poly Bristles. Round ends	Pack 12	7.00
H-RA-K111366	457mm (18") Molded Back. UV Stabilized Poly Bristles	Pack 12	7.00
H-RA-111386	912 with Vinyl End Caps	Pack 12	9.50
H-RA-111736	305mm (12") Spa Brush. UV Stabilized Poly Bristles	Pack 12	14.50
H-RA-111741	912-12 Spa Brush with 25.4 x 1.2m (1" x 4') Aluminum Pole	Pack 12	21.00
H-RA-K500012	152mm (6") Molded Back Algae Brush, Stainless Bristles	Pack 12	10.00
H-RA-111596	Multi-Purpose Brush. Molded Contour Shape Back Poly outer Bristles. Stiff inner bristles	Pack 12	15.50
H-RA-111598	Threaded End Wood Handle 23.8 mm x 1524mm (15/16" x 5')	Pack 12	7.50





## Wood Back Brushes (Classic Range)

Model Modell Modèle Modello Modelo	Description Beschreibung Désignation Descrizione Descripción	Quantity per case Bestellmenge Conditionnement Quantità per caso Cantidad por caja	List price € Listenpreis in € Prix de liste € Prezzo di listino€ P.V.P. €
H-RA-111584	254mm (10") Blue/White Crimped Bristles	25	8.50
H-RA-111586	254mm (10") Brown/White Straight Bristles	25	8.50
H-RA-111590	254mm (10") Mixed Brown Crimped Bristles	25	9.00



## Wood Handles

Model Modell Modèle Modello Modelo	Description Beschreibung Désignation Descrizione Descripción	Quantity per case Bestellmenge Conditionnement Quantità per caso Cantidad por caja	List price € Listenpreis in € Prix de liste € Prezzo di listino€ P.V.P. €
H-RA-111548	23.8mm x 1372mm (15/16" x 54") Clear w/tapered end	25	5.50
H-RA-111550	28.57mm x 1372mm (1 1/8" x 54") Sandalwood w/tapered end	25	6.50

## Scrubbers (Classic Range)

Model Modell Modèle Modello Modelo	Description Beschreibung Désignation Descrizione Descripción	Quantity per case Bestellmenge Conditionnement Quantità per caso Cantidad por caja	List price € Listenpreis in € Prix de liste € Prezzo di listino€ P.V.P. €
H-RA-111556	Scrubber. Multi Purpose. 3 interchangeable pads	25	10.00
H-RA-111581	Fixed Scrubber. Fine Grade pad on molded handle	25	3.50
H-RA-111560	Universal Scrubber. Swivel joint handle. 117.47mm x 254mm (4 5/8" x 10") Pad	12	17.00
H-RA-111566	Mini Scrub Brush. Poly Bristles on Molded Handle Grip	12	6.00
H-RA-111570	Tile Scrubber. Assembled with 1.2m (4') wood handle	12	16.50



## SKIMMERS / LEAF RAKES (Classic Range)

Model Modell Modèle Modello Modelo	Description Beschreibung Désignation Descrizione Descripción	Quantity per case Bestellmenge Conditionnement Quantità per caso Cantidad por caja	List price € Listenpreis in € Prix de liste € Prezzo di listino€ P.V.P. €
H-RA-121020	Deep Net Skimmer	12	19.00
H-RA-K121026	Skimmer. Blue molded frame with reinforced aluminum	12	7.00
H-RA-K121166	Spa/Above Ground Skimmer	12	4.00
H-RA-K121186	Long Handle Skimmer with 25.4mm x 1200mm (1" x 4') aluminum pole	12	6.00
H-RA-K500018	Unique shape skimmer. Blue net molded into polypropylene frame	12	6.50
H-RA-K500020	Long Handle Blue Net Skimmer with 25.4mm x 1200mm (1" x 4') aluminum pole	12	15.50
H-RA-K121106	Leaf Rake. 9.5mm (3/8") solid aluminum rod frame with blue fiberglass net	12	17.00
H-RA-K121126	Economic Leaf Rake. White Molded frame with reinforced aluminum. Raised lip. Blue fiberglass net	12	13.00
H-RA-K500009	Molded Frame with scraper. Deep blue netting	12	16.00





### FLOATING DISPENSERS (Classic Range)

Model Modell Modèle Modello Modelo	Description Beschreibung Désignation Descrizione Descripción	Quantity per case Bestellmenge Conditionnement Quantità per caso Cantidad por caja	List price € Listenpreis in € Prix de liste € Prezzo di listino€ P.V.P. €
H-RA-K171086	Large Floating dispenser. Twist lock cap. Hold 25.4 (1") or 76mm (3") tablets	12	5.00
H-RA-18856	Optional protective screen	bulk	3.00
H-RA-171060	330 Packed with protective screen installed	12	12.00
H-RA-K500014	Floating Dispenser. Friction cap. Holds 25.4 (1") or 76mm (3") tablets	12	6.00
H-RA-K171090	Spa Floating Dispenser. Beige / White	12	5.00
H-RA-K171074	Spa Floating Dispenser. Blue / White	12	5.00
H-RA-18855	Optional protective screen	bulk	1.60
H-RA-171130	Splasher Pool/Spa Floating Dispenser.	12	9.00



### LEAFTRAPS / LEAF EATERS (classic Range)

Model Modell Modèle Modello Modelo	Description Beschreibung Désignation Descrizione Descripción	Quantity per case Bestellmenge Conditionnement Quantità per caso Cantidad por caja	List price € Listenpreis in € Prix de liste € Prezzo di listino€ P.V.P. €
H-RA-211084	1 1/2" Snap Open Leaf Trap with debris bag, 1.2m of 38mm (3' of 1 1/2") vacuum hose	6	90.00
H-RA-211086	2" Snap Open Leaf Trap with trap bag, 1.2m of 50mm (3' of 2") vac hose	1	95.00
H-RA-211526	Optional Heavy Duty Basket	bulk	35.00
H-RA-172653	Optional 2.32m <sup>2</sup> (25 sq ft) Cartridge with plug	bulk	27.00
H-RA-K211036	Leaf Trap with wheels and brushes in display box	3	25.00
H-RA-K211046	Leaf Trap with wheels in bulk. No Display	6	25.00
H-RA-K500011	Leaf Eater II. New design compact version.	6	30.00



### THERMOMETERS (classic Range)

Model Modell Modèle Modello Modelo	Description Beschreibung Désignation Descrizione Descripción	Quantity per case Bestellmenge Conditionnement Quantità per caso Cantidad por caja	List price € Listenpreis in € Prix de liste € Prezzo di listino€ P.V.P. €
H-RA-141016	Economy Thermometer. ABS case. 1.2m (3') cord	BP 24	9.50
H-RA-141026	Economy Thermometer. ABS case. 1.2m (3') cord	Bulk 48	8.00
H-RA-K141036	Tube Thermometer. ABS molded tube. 1.2m (3') cord	BP 24	3.00
H-RA-K141047	Tube Thermometer. ABS molded tube. 1.2m (3') cord	Bulk 100	3.00
H-RA-141076	Chrome / Brass Thermometer	BP 24	25.00
H-RA-141086	Chrome / Brass Thermometer	Bulk 48	21.00
H-RA-K141106	Floating Thermometer. ABS molded tube	BP 24	3.50
H-RA-K141116	Floating Thermometer. ABS molded tube	Bulk 100	8.00
H-RA-K500015	Oval Thermometer. Molded ABS. Sealed tube. 1.2m (3') cord	BP 12	5.00
H-RA-K141201	E-Z Read Combo Sink/Float Thermometer	100	5.00



### TEST STRIPS (classic Range)

Model Modell Modèle Modello Modelo	Description Beschreibung Désignation Descrizione Descripción	Quantity per case Bestellmenge Conditionnement Quantità per caso Cantidad por caja	List price € Listenpreis in € Prix de liste € Prezzo di listino€ P.V.P. €
H-RA-161566	3-Way Free Cl/Br, pH, TA. Bilingual. 50 Strip Bottle	24	10.00
H-RA-161618	3-Way Free Cl/Br, pH, TA. Bilingual. 50 Strip Bottle	100 Bottles	10.00
H-RA-161568	5-Way Free Cl/Br, Total Cl, pH, TA, Total Hardness	12	17.50







### DPD TEST KITS (classic Range)

Model Modell Modèle Modello Modelo	Description Beschreibung Désignation Descrizione Descripción	Quantity per case Bestellmenge Conditionnement Quantità per caso Cantidad por caja	List price € Listenpreis in € Prix de liste € Prezzo di listino€ P.V.P. €
H-RA-151090	2 in 1 DPD Test Kit. Tests free Cl w/DPD tablets. pH w/21gr (3/4 oz) Phenol Red. Test cell and red case	24	15.50
H-RA-151260	Pro Pool & Spa Test Kit. Free, Total and Combined Cl, pH, TA and Water Hardness. #1 and #3 tablets and 5 solutions Red fold out box	12	31.00
H-RA-151190	Cl/Br All-in One Test Kit. Free, Total and Combine Cl and Br, pH, Acid demand and TA. Wide lucite test cell. DPD#1 and #3 tablets. 4 Solutions. Red stand up case	12	28.00
H-RA-151246	All-in One Test Kit. Free, Total and Combined Cl, pH, Acid Demand and TA. Wide lucite test cell. DPD#1 and #3 Tablets 4 solutions Red stand up case	12	28.00
H-RA-151248	All-in One Plus Test Kit. Free, Total and Combined Cl, pH, Acid Demand, Alkali Demand and TA. DPD#1 and #3 Tablets 5 solutions Red stand up case	12	32.00



### CHLORINE/pH TEST KITS (Classic Range)

Model Modell Modèle Modello Modelo	Description Beschreibung Désignation Descrizione Descripción	Quantity per case Bestellmenge Conditionnement Quantità per caso Cantidad por caja	List price € Listenpreis in € Prix de liste € Prezzo di listino€ P.V.P. €
H-RA-151076	2 in 1 Test Kit. Standard 2 bottle kit tests Cl and PH	24	15.00
H-RA-151083	2 in 1 Test Kit. Standard 2 bottle kit tests Cl and PH Blister pack Spanish	24	15.00
H-RA-151096	2 in 1 Test Kit. Standard 2 bottle kit tests Cl and PH Blister pack	24	13.00
H-RA-151726	Pool & Spa Test Kit. Cl/Br and pH. Larger test cell. 21gr (3/4 oz) reagents. Blue case. Packed 12 kits in counter display	24	15.50
H-RA-151626	Deluxe Cl/pH Test Kit. Pro test cell. 21gr (3/4 oz) reagents Blue 2 piece plastic box	24	21.00
H-RA-151606	Pro Pool & Spa Test Kit. Cl/Br, pH, TA and Water Hardness 7 solutions. Blue fold out case	12	32.00
H-RA-151186	All-in-One Test Kit. Standard 4-way kit in Blue stand up case Cl, pH, Acid Demand, and TA. Large Lucite test cell. 5 solutions	12	24.00
H-RA-151180	All-in-One Plus Test Kit. Cl, pH, Acid Demand, Alkali Demand, TA and Cyanuric Acid. Large Lucite test cell. 6 solutions and CA test tablets. Blue stand up case	12	30.00



### BRUSHES (Basic)

Model Modell Modèle Modello Modelo	Description Beschreibung Désignation Descrizione Descripción	Quantity per case Bestellmenge Conditionnement Quantità per caso Cantidad por caja	List price € Listenpreis in € Prix de liste € Prezzo di listino€ P.V.P. €
H-RA-P025	Deluxe wall brush with 18" aluminum back (curved)	bulk	6.50
H-RA-P025CB	Deluxe wall brush with 18" aluminum back (curved)	card board	6.50
H-RA-P036	Standard wall brush with 18" curved ABS molded	BU-12	4.20
H-RA-P036CB	Standard wall brush with 18" curved ABS molded	card board	4.20
H-RA-P024	10" stainless steel algae brush	bulk	6.00
H-RA-P024CB	10" stainless steel algae brush	card board	7.00
H-RA-P085	10" wall brush ABS molded	bulk	2.50
H-RA-P085CB	10" wall brush ABS molded	card board	2.50
H-RA-P077	Fixed scrubber fine grade pad on molded handle	bulk	1.50
H-RA-P077CB	Fixed scrubber fine grade pad on molded handle	card board	1.50







### POLES (Classic Range)

Model Modell Modèle Modello Modelo	Description Beschreibung Désignation Descrizione Descripción	Quantity per case Bestellmenge Conditionnement Quantità per caso Cantidad por caja	List price € Listenpreis in € Prix de liste € Prezzo di listino € P.V.P. €
H-RA-K191046	2 Piece Telescopic - Metal Cam 2.44m to 4.72m (8' to 15 1/2')	Pack 12	22.00
H-RA-K191066	2 Piece Telescopic - Metal Cam 1.20m to 2.29m (4' to 7 1/2')	Pack 12	14.00
H-RA-191306	2 Piece Telescopic - E-Z Lock Device 2.44m to 4.72m (8' to 15 1/2')	Pack 12	30.00
H-RA-191308	2 Piece Telescopic - E-Z Lock Device 1.20m to 2.29m (4' to 7 1/2')	Pack 12	18.00
H-RA-500070	2 Piece Telescopic - E-Z Lock Device 2.44m to 4.88m (8' to 16')	Pack 12	24.00
H-RA-500072	2 Piece Telescopic - E-Z Lock Device 1.82m to 3.64m (6' to 12')	Pack 12	16.00
H-RA-500074	2 Piece Telescopic - E-Z Lock Device 1.20m to 4.88m (4' to 8')	Pack 12	13.00
H-RA-K191116	1 Piece Straight Poles w/pole cap Full 4.88m (16') length	Pack 12	25.00
H-RA-K191106	1 Piece Straight Poles w/pole cap Full 3.64m (12') length	Pack 12	16.00
H-RA-191126	1 Piece Straight Poles w/pole cap 31.75mm x 1.2m (1 1/4" x 4') PVC	Pack 12	11.00
H-RA-191128	1 Piece Straight Poles w/pole cap 31.75mm x 1.82m (1 1/4" x 6') PVC	Pack 12	14.00



### VACUUMS (Classic Range)

Model Modell Modèle Modello Modelo	Description Beschreibung Désignation Descrizione Descripción	Quantity per case Bestellmenge Conditionnement Quantità per caso Cantidad por caja	List price € Listenpreis in € Prix de liste € Prezzo di listino € P.V.P. €
H-RA-201108	Econo Vac Head. Blue ABS with 2 enclosed weights	12	23.00
H-RA-K201350	Oval Vinyl Liner Vacuum	CS 6	22.00
H-RA-201356	Contour Vinyl Liner Vacuum	CS 6	55.00
H-RA-K201392	Econo Triangular Vac Head	CS 6	16.00
H-RA-K500016	Basic Contour Vinyl Vacuum	CS 6	22.00
H-RA-201398	Clear View Vacuum	CS 6	55.00
H-RA-K201112	305mm (12") Flexible Vacuum	CS 6	25.00
H-RA-201024	305mm (12") Flexible Vacuum	6	90.00
H-RA-201380	Slimline Flexible Vacuum. 356mm (14") width	CS 6	76.00
H-RA-201384	Economy Flexible Vacuum. 356mm (14") low profile	CS 6	70.00
H-RA-201062	Flex-A-Vac. Model #201 with chrome handle	boxed	78.00
H-RA-201064	Flex-A-Vac. Model #201 with chrome swivel handle	boxed	76.00
H-RA-K201388	Super Flex Vacuum. Economy 356mm (14")	CS 6	18.00
H-RA-K201146	Mini-Vac	12	28.00
H-RA-K500017	Uni-Vac II water jet vacuum	6	18.00



### CHLORINE DISPENSERS (Basic)

Model Modell Modèle Modello Modelo	Description Beschreibung Désignation Descrizione Descripción	Quantity per case Bestellmenge Conditionnement Quantità per caso Cantidad por caja	List price € Listenpreis in € Prix de liste € Prezzo di listino € P.V.P. €
H-RA-P033	Floating reinforced polymer chlorine dispenser, twist lock cap and adjustable ring (5" diameter)	bulk	1.50
H-RA-P063	Floating reinforced polymer chlorine dispenser, twist lock cap and adjustable ring (7" diameter)	bulk	3.50
H-RA-P027	Floating reinforced polymer chlorine dispenser, twist lock cap and adjustable ring (7" diameter)	bulk	4.00





### FLEXIBLE VACUUMS (Basic)

Model Modell Modèle Modello Modelo	Description Beschreibung Désignation Descrizione Descripción	Quantity per case Bestellmenge Conditionnement Quantità per caso Cantidad por caja	List price € Listenpreis in € Prix de liste € Prezzo di listino€ P.V.P. €
H-RA-P053	356mm (14") flexible vacuum with side brush and factory set solid molded replaceable wheel (vinyl/concrete)	CS-6	15.50
H-RA-P053CS	356mm (14") flexible vacuum with side brush and factory set solid molded replaceable wheel (vinyl/concrete)	clam shell	13.50
H-RA-P051	356mm (14") flex vac w/covered weights (concrete only)	bulk	12.00
H-RA-P051CS	356mm (14") flex vac w/covered weights (concrete only)	clam shell	12.00

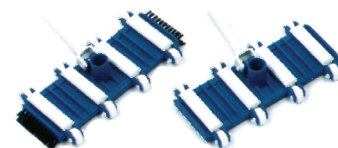

### POOL VACUUMS (Basic)

Model Modell Modèle Modello Modelo	Description Beschreibung Désignation Descrizione Descripción	Quantity per case Bestellmenge Conditionnement Quantità per caso Cantidad por caja	List price € Listenpreis in € Prix de liste € Prezzo di listino€ P.V.P. €
H-RA-P048	Triangular vacuum head with protective vinyl bumper and swivel connection	bulk	7.50
H-RA-P048CS	Triangular vacuum head with protective vinyl bumper and swivel connection	clam shell	8.50
H-RA-P052	Triangular shaped, weight See-trough design with protective vinyl bumper	bulk	13.00
H-RA-P052CS	Triangular shaped, weight See-trough design with protective vinyl bumper	clam shell	14.00
H-RA-P023	Special contour shape deluxe vacuum with protective vinyl bumper and weights (w/full bumper)	bulk	6.00
H-RA-P023CS	Special contour shape deluxe vacuum with protective vinyl bumper and weights (w/full bumper)	clam shell	8.00
H-RA-P107	Blue ABS w/enclosed weights for easier cleaning contour	bulk	7.00
H-RA-P107CS	Blue ABS w/enclosed weights for easier cleaning contour	clam shell	8.00
H-RA-P108	Large shaped white ABS vacuum w/protective vinyl bumper, weights and side brushes	bulk	9.00
H-RA-P108CS	Large shaped white ABS vacuum w/protective vinyl bumper, weights and side brushes	clam shell	11.00
H-RA-P109	Large shaped white ABS vacuum w/protective vinyl bumper and weights	bulk	8.00
H-RA-P109CS	Large shaped white ABS vacuum w/protective vinyl bumper and weights	clam shell	9.50



### THERMOMETERS (Basic)

Model Modell Modèle Modello Modelo	Description Beschreibung Désignation Descrizione Descripción	Quantity per case Bestellmenge Conditionnement Quantità per caso Cantidad por caja	List price € Listenpreis in € Prix de liste € Prezzo di listino€ P.V.P. €
H-RA-P080	E-Z read combo sink or float thermometer includes snap on/off flotation top	bulk	2.00
H-RA-P080CS	E-Z read combo sink or float thermometer includes snap on/off flotation top	clam shell	3.00
H-RA-P081	Deluxe float thermometer for pools ans spas. °F and °C scale	bulk	1.50
H-RA-P081BP	Deluxe float thermometer for pools ans spas. °F and °C scale	blister pack	2.00
H-RA-P082	Deluxe float thermometer with glass tube. °F and °C scale	bulk	1.50
H-RA-P082BP	Deluxe float thermometer with glass tube. °F and °C scale	blister pack	2.00
H-RA-P083	Animal shaped flexible polymer thermometer in 4 different shapes. °F and °C scale	bulk	3.00
H-RA-P083BP	Animal shaped flexible polymer thermometer in 4 different shapes. °F and °C scale	blister pack	3.50



### LEAF SKIMMERS (Basic)

Model Modell Modèle Modello Modelo	Description Beschreibung Désignation Descrizione Descripción	Quantity per case Bestellmenge Conditionnement Quantità per caso Cantidad por caja	List price € Listenpreis in € Prix de liste € Prezzo di listino€ P.V.P. €
H-RA-P030	Deluxe Pro-Series deep leaf skimmer	BU-12	8.00
H-RA-P030CB	Deluxe Pro-Series deep leaf skimmer	card board	9.00
H-RA-P087	Deluxe heavy duty leaf skimmer aluminum frame with blue plastic handle	bulk	7.00
H-RA-P087CB	Deluxe heavy duty leaf skimmer aluminum frame with blue plastic handle	card board	8.00
H-RA-P026	Budget priced leaf skimmer Polyester screen molded into polypropylene frame	bulk	2.00
H-RA-P026CB	Budget priced leaf skimmer Polyester screen molded into polypropylene frame	card board	3.00
H-RA-P043	Ultra deep leaf skimmer with aluminum frame plastic covered and durable net with blue plastic handle	bulk	8.00
H-RA-P043CB	Ultra deep leaf skimmer with aluminum frame plastic covered and durable net with blue plastic handle	card board	8.00
H-RA-P031	Deluxe Pro-Series leaf skimmer	bulk	6.00
H-RA-P031CB	Deluxe Pro-Series leaf skimmer	card board	5.50
H-RA-P042	Ultra deep leaf skimmer	bulk	4.00
H-RA-P042CB	Ultra deep leaf skimmer durable net	card board	4.00
H-RA-P079	Triple hook heavy-duty polymer accessories hanger (pair) hardware included	bulk	2.00
H-RA-P079BP	Triple hook heavy-duty polymer accessories hanger (pair) hardware included	blister pack	2.50



### POLES (Basic)

Model Modell Modèle Modello Modelo	Description Beschreibung Désignation Descrizione Descripción	Quantity per case Bestellmenge Conditionnement Quantità per caso Cantidad por caja	List price € Listenpreis in € Prix de liste € Prezzo di listino€ P.V.P. €
H-RA-P106	Leaf Rake w/ 4' Silver anodized aluminum pole	bulk	5,00
H-RA-P106CB	Leaf Rake w/ 4' Silver anodized aluminum pole	card board	5,50
H-RA-P044	Leaf Rake w/ 5' aluminum pole	BU-24	7,00
H-RA-P044CB	Leaf Rake w/ 5' aluminum pole	card board	7,50
H-RA-P095	Deluxe 8' to 16' extruded telescopic pole available in blue	bulk	18,00
H-RA-P096	Deluxe 6' to 12' extruded telescopic pole available in blue	bulk	16,00
H-RA-P097	Deluxe 4' to 8' extruded telescopic pole available in blue	bulk	12,00



### TESTKITS (Basic)

Model Modell Modèle Modello Modelo	Description Beschreibung Désignation Descrizione Descripción	Quantity per case Bestellmenge Conditionnement Quantità per caso Cantidad por caja	List price € Listenpreis in € Prix de liste € Prezzo di listino€ P.V.P. €
H-RA-P029	Test kit for Chlorine and pH.	bulk	4,50
H-RA-P029BP	Test kit for Chlorine and pH.	blisper pack	5,50
H-RA-P102	Test kit refill (14gr (1/2oz) Orthotolidine and phenol)	bulk	1,50
H-RA-P102BP	Test kit refill (14gr (1/2oz) Orthotolidine and phenol)	blisper pack	2,00







# Product Catalogue

Produkt Katalog - Catalogue Général - Catalogo Prodotti - Catálogo

TOGETHER WE BUILD DREAMS THAT LAST

**STA-RITE®**  



Sandfilters / Sandfilteranlagen / Filtres à sable / Filtros de arena / Filtri a sabbia	39
SRS	39
SRS Premium	39
SRD	40
SRC	40
Cristal-Flo	41
Filter / Filtres / Filtri / Filtros	42
System 3	42
System 2	43
Cartridge Filter / Kartuschenfilter / Filtre à cartouche / Filtri a cartuccia / Filtros de cartucho	44
Posi-Flo II	44
Posi-Clear	44
PRC	44
Remplacement Cartridges / Ersatzkartuschen / Cartouches de Remplacement /Cartuccie di ricambio / Cartuchos de repuesto	45
System 3	45
System 2	45
Posi-Flo II	45
Posi-Clear	46
PRC	46
Onga Filtration Kits	47
Valves / Ventile / Vannes / Ventiele / Valvulas	48
Side Mount	48
Top Mount	48
Swimming Pool Pumps / Schwimmbadpumpen / Pompes pour piscine / Pompe per piscina / Bombas para piscinas	49
(S)5P2R	49
(SW)5P6R	50
5MPR	51
5JWP	51
5ABG	52
5BR	52
Onga BR400E	53
Onga 800E	53
LTP	53
Pump-Exchange Set / Austauschatz / Jeu d'échange /Set ricambio pompa / Juego recambio para bombas	54
5P2R	54
5SP2R	54
5BR	54
Prefilter and gasket kits / Vorfilterkörper und Dichtungssätze /Préfiltres et joints / Prefiltri e cestelli / Prefiltros y juego de juntas	55
Maintenance accessories / Zubehör / Matériel d'entretien / Accessori / Accesorios	56-59





## Sandfilters / Sandfilteranlagen / Filtres à sable Filtros de arena / Filtri a sabbia



### SRS

#### Sandfilter Side mount

Filtre à sable  
Montage Latéral

Filtri a sabbia,  
valvola montaggio  
laterale

Filtro de arena  
montaje lateral

Model Modèle Modell Modello Modelo	Flow Rates m <sup>3</sup> /h at 50 m <sup>3</sup> /h/m <sup>2</sup> Débit en m <sup>3</sup> /h basé sur 50 m <sup>3</sup> /h/m <sup>2</sup> Filterleistung m <sup>3</sup> /h bei 50 m <sup>3</sup> /h/m <sup>2</sup> Flusso max m <sup>3</sup> /h a 50 m <sup>3</sup> /h/m <sup>2</sup> Caudal máx. en m <sup>3</sup> /h a 50 m <sup>3</sup> /h/m <sup>2</sup>	Ø - mm	Height mm Hauteur mm Höhe mm Altezza mm Altura mm	Connection Raccordement Anschluss Connessione Conexión	List price € Prix de liste € Listenpreis in € Prezzo di listino € P.V.P. €
SRS50 *	10,0	500	630	D 50	590,00
SRS50-H *	10,0	500	1000	D 50	643,00
SRS61 *	14,0	610	925	D 50	756,00
SRS61-HS *	14,0	610	1080	D 50	988,00
SRS76 *	22,5	765	760	D 63	1 033,00
SRS76-H *	22,5	765	1150	D 63	1 149,00
SRS76-HS *	22,5	765	1150	D 63	1 379,00
SRS92 *	32,5	920	940	D 63	1 109,00
SRS92-HS *	32,5	920	1150	D 63	1 437,00
SRS108	46,0	1080	1110	D 90	2 740,00
SRS125	61,5	1250	1600	D 90	3 637,00
SRS140	77,0	1400	1800	D 110	4 332,00
SRS160	100,0	1600	1900	D 125	7010,00

\* inkl. 6-Wege Ventil / incl. 6-way valve / avec vanne 6-voies / Incluye válvula de 6 vías

### SRS - Premium

#### Sandfilteranlagen

Sand Filter System

Kit de filtration  
à sable

Sistemi di  
filtraggio  
a sabbia

Sistema de  
filtración de  
arena



Model Modèle Modell Modello Modelo	"Pump Flow Rates at 6 m height" "Débit de la pompe à 6 m hmt" "Pumpenleistung in m <sup>3</sup> /h bei 6 m WS" Flusso max pompa 6m Caudal de la bomba a 6 m altura	"Maximum Filter Flow Rates m <sup>3</sup> /h" "Débit maximal du filtre en m <sup>3</sup> /h" Maximum Filterleistung m <sup>3</sup> /h Flusso max filtro m <sup>3</sup> /h Caudal máx. filtro m <sup>3</sup> /h	Description/Désignation/ Beschreibung/Descripción Filter/Filter/Filtre/Filtro Pump/Pompes/Pumpe/Bomba	List price € Prix de liste € Listenpreis in € Prezzo di listino € P.V.P. €
SRS50-B1	6,0	10,0	Ø500mm + 5P2RB-1 (0,25kW / 230Volt)	1 085,00
SRS50-B3	6,0	10,0	Ø500mm + 5P2RB-3 (0,25kW / 400Volt)	1 071,00
SRS50-C1	8,5	10,0	Ø500mm + 5P2RC-1 (0,37kW / 230Volt)	1 086,00
SRS50-C3	8,5	10,0	Ø500mm + 5P2RC-3 (0,37kW / 400Volt)	1 072,00
SRS61-C1	8,5	14,0	Ø610mm + 5P2RC-1 (0,37kW / 230Volt)	1 293,00
SRS61-C3	8,5	14,0	Ø610mm + 5P2RC-3 (0,37kW / 400Volt)	1 271,00
SRS61-D1	13,5	14,0	Ø610mm + 5P2RD-1 (0,55kW / 230Volt)	1 311,00
SRS61-D3	13,5	14,0	Ø610mm + 5P2RD-3 (0,55kW / 400Volt)	1 290,00

0003 Aufpreis für die komplette Montage der Filteranlage  
Extra cost for complete assembled unit upon platform base  
Prix supplémentaire pour l'assemblage complet sur une platine de filtration  
Coste extra por unidad completamente ensamblada sobre la plataforma de filtración 217,00



Sandfilters / Sandfilteranlagen / Filtres à sable  
Filtros de arena / Filtri a sabbia

## SRD



**DIN-Sandfilter (1,2 m filtration bed height)**

Filtre à sable DIN

Filtri a sabbia DIN (letto filtrante 1,2 m)

Filtro de arena DIN (1.2 m altura techo filtración)



Model Modèle Modell Modello Modelo	Flow Rates m <sup>3</sup> /h at 50 m <sup>3</sup> /h/m <sup>2</sup> Débit en m <sup>3</sup> /h basé sur 50 m <sup>3</sup> /h/m <sup>2</sup> Filterleistung m <sup>3</sup> /h bei 50 m <sup>3</sup> /h/m <sup>2</sup> Flusso max m <sup>3</sup> /h Caudal máx. en m <sup>3</sup> /h a 50 m <sup>3</sup> /h/m <sup>2</sup>	Ø - mm	Height mm Hauteur mm Höhe mm Altezza mm Altura mm	Connection Raccordement Anschluss Connezione Conexión	List price € Prix de liste € Listenpreis in€ Prezzo di listino € P.V.P. €
SRD61-21	8,7	610	2100	D75 / D90	3 140,00
SRD76-22	13,5	765	2200	D90 / D110	3 900,00
SRD92-24	19,5	920	2325	D90 / D110	4 925,00
SRD108-25	27,6	1080	2450	D110 / D140	6160,00
SRD125-25	36,8	1250	2530	D140 / D160	7777,00
SRD145-27	49,5	1450	2709	D140 / D160	11 515,00
SRD180-29	76,3	1800	2850	D160 / D180	22 375,00

## SRC



**Sandfilter (1,0 m filtration bed height)**

Filtre à sable

Filtri a sabbia

Filtro de arena (1 m altura techo filtración)



Model Modèle Modell Modello Modelo	Flow Rates m <sup>3</sup> /h at 50 m <sup>3</sup> /h/m <sup>2</sup> Débit en m <sup>3</sup> /h basé sur 50 m <sup>3</sup> /h/m <sup>2</sup> Filterleistung m <sup>3</sup> /h bei 50 m <sup>3</sup> /h/m <sup>2</sup> Flusso max m <sup>3</sup> /h Caudal máx. en m <sup>3</sup> /h a 50 m <sup>3</sup> /h/m <sup>2</sup>	Ø - mm	Height mm Hauteur mm Höhe mm Altezza mm Altura mm	Connection Raccordement Anschluss Connezione Conexión	List price € Prix de liste € Listenpreis in€ Prezzo di listino € P.V.P. €
SRC61-16	14,5	610	1600	D 63	1 177,00
SRC61-18	14,5	610	1800	D 63	1 392,00
SRC76-16	22,5	765	1600	D 63	1 518,00
SRC76-18	22,5	765	1800	D 63	1 705,00
SRC92-18	32,5	920	1800	D 90	2 157,00
SRC92-24	32,5	920	2325	D 90	2 417,00
SRC108-25	46,0	1080	2450	D 90	4 128,00
SRC125-25	61,5	1250	2530	D 110	5 667,00
SRC145-28	82,5	1450	2710	D 125	7 321,00
SR999	Optional sight glass - Avec hublot - Cristal de visión opcional				400,00



Sandfilters / Sandfilteranlagen / Filtres à sable  
Filtros de arena / Filtri a sabbia

## CRISTAL-FLO

### 4-way valve

4-wege Ventil

Vanne 4-voies

Valvola a 4 vie

Válvula 4 vías



Model Modèle Modell Modello Modelo	Max. Flow Rates m <sup>3</sup> /h Débit max. en m <sup>3</sup> /h Max. Filterleistung m <sup>3</sup> /h Flusso max m <sup>3</sup> /h Caudal máx. en m <sup>3</sup> /h	Description Désignation Beschreibung Descrizione Descripción	List price € Prix de liste € Listenpreis in € Prezzo di listino € P.V.P. €
T-380E	5,0 Ø15" (380mm)	Kessel*/Filter Tank*/Cuve de filtre*/Serbatoio/Tanque de filtración*	297,00
T-430E	7,4 Ø17" (430mm)	Kessel*/Filter Tank*/Cuve de filtre*/Serbatoio/Tanque de filtración*	316,00
T-500E	10,0 Ø20" (500mm)	Kessel*/Filter Tank*/Cuve de filtre*/Serbatoio/Tanque de filtración*	346,00
T-600E	14,2 Ø24" (600mm)	Kessel*/Filter Tank*/Cuve de filtre*/Serbatoio/Tanque de filtración*	396,00

\* incl. 4-way valve / inkl. 4-Wege Ventil / avec vanne 4-voies / Inclusa valvola a 4 vie / Incluye válvula de 4 vías

### 6-way valve

6-wege Ventil

Vanne 6-voies

Valvola a 6 vie

Válvula 6 vías

Model Modèle Modell Modello Modelo	Max. Flow Rates m <sup>3</sup> /h Débit max. en m <sup>3</sup> /h Max. Filterleistung m <sup>3</sup> /h Flusso max m <sup>3</sup> /h Caudal máx. en m <sup>3</sup> /h	Description Désignation Beschreibung Descrizione Descripción	List price € Prix de liste € Listenpreis in € Prezzo di listino € P.V.P. €
T-380	5,0 Ø15" (380mm)	Kessel* / Filter Tank* / Cuve de filtre* / Tanque de filtración*	319,00
T-430	7,4 Ø17" (430mm)	Kessel* / Filter Tank* / Cuve de filtre* / Tanque de filtración*	336,00
T-500	10,0 Ø20" (500mm)	Kessel* / Filter Tank* / Cuve de filtre* / Tanque de filtración*	365,00
T-600	14,2 Ø24" (600mm)	Kessel* / Filter Tank* / Cuve de filtre* / Tanque de filtración*	411,00
T-760	22,5 Ø30" (760mm)	Kessel* / Filter Tank* / Cuve de filtre* / Tanque de filtración*	829,00

\* incl. 6-way valve / inkl. 6-Wege Ventil / avec vanne 6-voies / Inclusa valvola a 6 vie / Incluye válvula de 6 vías

## Sand Filter System

Sandfilteranlagen

Kit de filtration

à sable

Sistemi di

filtraggio

a sabbia

Sistema de

filtración de

arena

Model	"Pump Flow Rates at 6 m height" "Débit de la pompe à 6 m hmt" "Pumpenleistung in m <sup>3</sup> /h bei 6 m WS" Flusso max pompa 6m Caudal de la bomba a 6 m altura	"Maximum Filter Flow Rates m <sup>3</sup> /h" "Débit maximal du filtre en m <sup>3</sup> /h" Maximum Filterleistung m <sup>3</sup> /h Flusso max filtro m <sup>3</sup> /h Caudal máx. filtro m <sup>3</sup> /h	Description/Désignation/ Beschreibung/Descripción Filter/Filter/Filtre/Filtro Pump/Pompes/Pumpe/Bomba	List price € Prix de liste € Listenpreis in € Prezzo di listino € P.V.P. €
CR17-D1	13,0	7,4	Ø17" (430mm) + 5JWPD-1 (0,55kW / 230Volt)	777,00
CR20-E1	15,0	10,0	Ø20" (500mm) + 5JWPE-1 (0,75kW / 230Volt)	799,00



## System 3



### Sandfilter

Filtre à sable

Filtri a sabbia

Filtro de arena

Model Modèle Modell Modello Modelo	Max. Flow Rates m <sup>3</sup> /h Débit max. en m <sup>3</sup> /h Max. Filterleistung m <sup>3</sup> /h Flusso max m <sup>3</sup> /h Caudal máx. en m <sup>3</sup> /h	Description Désignation Beschreibung Descrizione Descripción	List price € Prix de liste € Listenpreis in € Prezzo di listino € P.V.P. €
S7S50	11,0	Sandfilter* / Sand Filter* / Filtre à sable* / Filtros de arena* / Filtri a sabia	823,00
S8S70	16,0	Sandfilter* / Sand Filter* / Filtre à sable* / Filtros de arena* / Filtri a sabia	906,00

\* Filter werden ohne Ventil geliefert / Multiport valve not included / Les filtres sont livrés sans la vanne / Valvola multivie non inclusa / Válvula multivías no incluida

### Cartridge filters

Kartuschenfilter

Filtre à cartouche

Filtri a cartuccia

Filtros de cartucho

Model Modèle Modell Modello Modelo	Max. Flow Rates m <sup>3</sup> /h Débit max. en m <sup>3</sup> /h Max. Filterleistung m <sup>3</sup> /h Flusso max m <sup>3</sup> /h Caudal máx. en m <sup>3</sup> /h	Description Désignation Beschreibung Descrizione Descripción	List price € Prix de liste € Listenpreis in € Prezzo di listino € P.V.P. €
S7M120	22,6	Kartuschenfilter / Cartridge Filter / Filtre à cartouche / Filtri a cartuccia / Filtros de cartucho	1 245,00
S7M400	26,0	Kartuschenfilter / Cartridge Filter / Filtre à cartouche / Filtri a cartuccia / Filtros de cartucho	1 394,00
S8M150	28,0	Kartuschenfilter / Cartridge Filter / Filtre à cartouche / Filtri a cartuccia / Filtros de cartucho	1 528,00
S8M500	29,4	Kartuschenfilter / Cartridge Filter / Filtre à cartouche / Filtri a cartuccia / Filtros de cartucho	1 604,00

### D.E. Filters

Kieselgurfilter

Filtre à diatomée

Filtri a diatomee

Filtros de diatomeas

Model Modèle Modell Modello Modelo	Max. Flow Rates m <sup>3</sup> /h Débit max. en m <sup>3</sup> /h Max. Filterleistung m <sup>3</sup> /h Flusso max m <sup>3</sup> /h Caudal máx. en m <sup>3</sup> /h	Description Désignation Beschreibung Descrizione Descripción	List price € Prix de liste € Listenpreis in € Prezzo di listino € P.V.P. €
S7D75	16,7	Kieselgurfilter* / D.E. Filter* / Filtre à diatomée* / Filtros de diatomeas* / Filtri a diatomee*	1 008,00
S8D110	24,0	Kieselgurfilter* / D.E. Filter* / Filtre à diatomée* / Filtros de diatomeas* / Filtri a diatomee*	1 199,00
S7MD60	27,2	Kieselgurfilter* / D.E. Filter* / Filtre à diatomée* / Filtros de diatomeas* / Filtri a diatomee*	1 195,00
S7MD72	32,7	Kieselgurfilter* / D.E. Filter* / Filtre à diatomée* / Filtros de diatomeas* / Filtri a diatomee*	1 244,00

\* Filter werden ohne Ventil geliefert / Multiport valve not included / Les filtres sont livrés sans la vanne / Valvola multivie non inclusa / Válvula multivías no incluida

### Valves

Ventile

Vannes

Valvoa

Válvulas

Model Modèle Modell Modello Modelo	Max. Flow Rates m <sup>3</sup> /h Débit max. en m <sup>3</sup> /h Max. Filterleistung m <sup>3</sup> /h Flusso max m <sup>3</sup> /h Caudal máx. en m <sup>3</sup> /h	Description Désignation Beschreibung Descrizione Descripción	List price € Prix de liste € Listenpreis in € Prezzo di listino € P.V.P. €
WC212-144P		6-way valve - 2" for System3 Sandfilter and D.E. Filter (S7D75/S8D110) 6 Wegeventil - 2" Anschluß für SYSTEM3 Sand- und Kieselgurfilter (S7D75/S8D110) Vanne 6-voies - 2" pour System3 Sable et Diatomée (S7D75/S8D110) Valvola 6 vie per System3 a sabbia e diatomee / Válvula de 6 vías para System 3 de arena y de diatomeas (S7d75/s8d110)	145,00





## System 2

### Cartridge filters

Kartuschenfilter  
Filtre à cartouche  
Filtri a cartuccia  
Filtros de cartucho

Model Modèle Modell Modello Modelo	Max. Flow Rates m <sup>3</sup> /h Débit max. en m <sup>3</sup> /h Max. Filterleistung m <sup>3</sup> /h Flusso max m <sup>3</sup> /h Caudal máx. en m <sup>3</sup> /h	Description Désignation Beschreibung Descrizione Descripción	List price € Prix de liste € Listenpreis in € Prezzo di listino € P.V.P. €
PLM100	11	Kartuschenfilter / Cartridge Filter / Filtre à cartouche / Filtri a cartuccia / Filtros de cartucho	478,00
PLM150	25	Kartuschenfilter / Cartridge Filter / Filtre à cartouche / Filtri a cartuccia / Filtros de cartucho	496,00
PLM175	27	Kartuschenfilter / Cartridge Filter / Filtre à cartouche / Filtri a cartuccia / Filtros de cartucho	510,00
PLM200	27	Kartuschenfilter / Cartridge Filter / Filtre à cartouche / Filtri a cartuccia / Filtros de cartucho	515,00

### D.E. Filters

Kieselgumfilter  
Filtre à diatomée  
Filtri a diatomee  
Filtros de diatomeas

Model Modèle Modell Modello Modelo	Max. Flow Rates m <sup>3</sup> /h Débit max. en m <sup>3</sup> /h Max. Filterleistung m <sup>3</sup> /h Flusso max m <sup>3</sup> /h Caudal máx. en m <sup>3</sup> /h	Description Désignation Beschreibung Descrizione Descripción	List price € Prix de liste € Listenpreis in € Prezzo di listino € P.V.P. €
PLD50	11	Kieselgumfilter / D.E. Filter / Filtre à diatomée / Filtros de diatomeas / Filtri a diatomee	530,00
PLD70	13	Kieselgumfilter / D.E. Filter / Filtre à diatomée / Filtros de diatomeas / Filtri a diatomee	570,00

### Valves

Ventile  
Vannes  
Valvoa  
Válvulas

Model Modèle Modell Modello Modelo	Max. Flow Rates m <sup>3</sup> /h Débit max. en m <sup>3</sup> /h Max. Filterleistung m <sup>3</sup> /h Flusso max m <sup>3</sup> /h Caudal máx. en m <sup>3</sup> /h	Description Désignation Beschreibung Descrizione Descripción	List price € Prix de liste € Listenpreis in € Prezzo di listino € P.V.P. €
WC212-144P		6-way valve - 2" for System3 Sandfilter and D.E. Filter (S7D75/S8D110) 6 Wegeventil - 2" Anschluß für SYSTEM3 Sand- und Kieselgumfilter (S7D75/S8D110) Vanne 6-voies - 2" pour System3 Sable et Diatomée (S7D75/S8D110) Valvola 6 vie per System3 a sabbia e diatomee / Válvula de 6 vías para Válvula de 6 vías para System 3 de arena y de diatomeas (S7d75/s8d110)	145,00



Cartridge Filter / Kartuschenfilter / Filtre à cartouche  
Filtri a cartuccia / Filtros de cartucho

## POSI-FLO II

Model Modèle Modell Modello Modelo	Max. Flow Rates m <sup>3</sup> /h Débit max. en m <sup>3</sup> /h Max. Filterleistung m <sup>3</sup> /h Flusso max m <sup>3</sup> /h Caudal máx. en m <sup>3</sup> /h	Description Désignation Beschreibung Descrizione Descripción	List price € Prix de liste € Listenpreis in € Prezzo di listino € P.V.P. €
PTM50	8	Kartuschenfilter / Cartridge Filter / Filtre à cartouche / Filtri a cartuccia / Filtros de cartucho	312,00
PTM70	11	Kartuschenfilter / Cartridge Filter / Filtre à cartouche / Filtri a cartuccia / Filtros de cartucho	325,00
PTM100	17	Kartuschenfilter / Cartridge Filter / Filtre à cartouche / Filtri a cartuccia / Filtros de cartucho	370,00
PTM135	22	Kartuschenfilter / Cartridge Filter / Filtre à cartouche / Filtri a cartuccia / Filtros de cartucho	466,00



## POSI-CLEAR

Model Modèle Modell Modello Modelo	Max. Flow Rates m <sup>3</sup> /h Débit max. en m <sup>3</sup> /h Max. Filterleistung m <sup>3</sup> /h Flusso max m <sup>3</sup> /h Caudal máx. en m <sup>3</sup> /h	Description Désignation Beschreibung Descrizione Descripción	List price € Prix de liste € Listenpreis in € Prezzo di listino € P.V.P. €
PXC75	11	Kartuschenfilter / Cartridge Filter / Filtre à cartouche / Filtri a cartuccia / Filtros de cartucho	290,00
PXC95	21	Kartuschenfilter / Cartridge Filter / Filtre à cartouche / Filtri a cartuccia / Filtros de cartucho	306,00
PXC125	28	Kartuschenfilter / Cartridge Filter / Filtre à cartouche / Filtri a cartuccia / Filtros de cartucho	347,00
PXC150	34	Kartuschenfilter / Cartridge Filter / Filtre à cartouche / Filtri a cartuccia / Filtros de cartucho	367,00



## PRC

Model Modèle Modell Modello Modelo	Max. Flow Rates m <sup>3</sup> /h Débit max. en m <sup>3</sup> /h Max. Filterleistung m <sup>3</sup> /h Flusso max m <sup>3</sup> /h Caudal máx. en m <sup>3</sup> /h	Description Désignation Beschreibung Descrizione Descripción	List price € Prix de liste € Listenpreis in € Prezzo di listino € P.V.P. €
PRC50	11,4	Kartuschenfilter / Cartridge Filter / Filtre à cartouche / Filtri a cartuccia / Filtros de cartucho	197,00
PRC75	17,0	Kartuschenfilter / Cartridge Filter / Filtre à cartouche / Filtri a cartuccia / Filtros de cartucho	218,00





## Remplacement Cartridges / Ersatzkartuschen / Cartouches de Remplacement Cartucce di ricambio / Cartuchos de repuesto

### SYSTEM 3

Model Modèle Modell Modello Modelo	Description Désignation Beschreibung Descrizione Descripción	List price € Prix de liste € Listenpreis in € Prezzo di listino € P.V.P. €
25021-0200S	Kartusche/Cartridge/Cartouche/Cartucce/Cartucho - S7M120 innen / inside / intérieur / interna / interior	222,00
25022-0201S	Kartusche/Cartridge/Cartouche/Cartucce/Cartucho - S7M120 aussen / outside / extérieur / esterna / exterior	381,00
25021-0223S	Kartusche/Cartridge/Cartouche/Cartucce/Cartucho - S7M400 innen / inside / intérieur / interna / interior	225,00
25022-0224S	Kartusche/Cartridge/Cartouche/Cartucce/Cartucho - S7M400 aussen / outside / extérieur / esterna / exterior	386,00
25021-0202S	Kartusche/Cartridge/Cartouche/Cartucce/Cartucho - S8M150 innen / inside / intérieur / interna / interior	343,00
25022-0203S	Kartusche/Cartridge/Cartouche/Cartucce/Cartucho - S8M150 aussen / outside / extérieur / esterna / exterior	481,00
25021-0224S	Kartusche/Cartridge/Cartouche/Cartucce/Cartucho - S8M500 innen / inside / intérieur / interna / interior	346,00
25022-0225S	Kartusche/Cartridge/Cartouche/Cartucce/Cartucho - S8M500 aussen / outside / extérieur / esterna / exterior	484,00
25023-0160S	Kartusche/Cartridge/Cartouche/Cartucce/Cartucho - S7MD60	518,00
25023-0172S	Kartusche/Cartridge/Cartouche/Cartucce/Cartucho - S7MD72	571,00

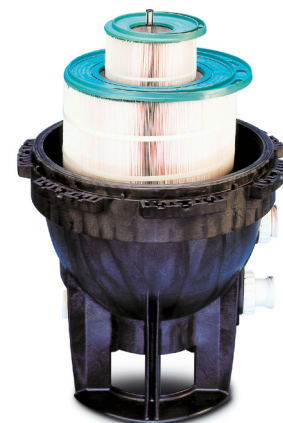

### SYSTEM 2

Model Modèle Modell Modello Modelo	Description Désignation Beschreibung Descrizione Descripción	List price € Prix de liste € Listenpreis in € Prezzo di listino € P.V.P. €
27002-0030S	Kartusche/Cartridge/Cartouche/Cartucce/Cartucho - PLD50	282,00
27002-0036S	Kartusche/Cartridge/Cartouche/Cartucce/Cartucho - PLD70	287,00
27002-0100S	Kartusche/Cartridge/Cartouche/Cartucce/Cartucho - PLM100	295,00
27002-0150S	Kartusche/Cartridge/Cartouche/Cartucce/Cartucho - PLM150	322,00
27002-0175S	Kartusche/Cartridge/Cartouche/Cartucce/Cartucho - PLM175	338,00
27002-0200S	Kartusche/Cartridge/Cartouche/Cartucce/Cartucho - PLM200	353,00



### POSI-FLO II

Model Modèle Modell Modello Modelo	Description Désignation Beschreibung Descrizione Descripción	List price € Prix de liste € Listenpreis in € Prezzo di listino € P.V.P. €
WC108-55S2X	Kartusche/Cartridge/Cartouche/Cartucce/Cartucho - PTM35	66,00
WC108-56S2X	Kartusche/Cartridge/Cartouche/Cartucce/Cartucho - PTM50	74,00
WC108-57S2X	Kartusche/Cartridge/Cartouche/Cartucce/Cartucho - PTM70	87,00
WC108-58S2X	Kartusche/Cartridge/Cartouche/Cartucce/Cartucho - PTM100	114,00
WC108-70S2X	Kartusche/Cartridge/Cartouche/Cartucce/Cartucho - PTM135	141,00



Remplacement Cartridges / Ersatzkartuschen / Cartouches de Remplacement  
Cartucce di ricambio / Cartuchos de repuesto

## POSI-CLEAR

Model Modèle Modell Modello Modelo	Description Désignation Beschreibung Descrizione Descripción	List price € Prix de liste € Listenpreis in € Prezzo di listino € P.V.P. €
25230-0075S	Kartusche/Cartridge/Cartouche/Cartucce/Cartucho - PXC75	98,00
25230-0095S	Kartusche/Cartridge/Cartouche/Cartucce/Cartucho - PXC95	113,00
25230-0125S	Kartusche/Cartridge/Cartouche/Cartucce/Cartucho - PXC125	138,00
25230-0150S	Kartusche/Cartridge/Cartouche/Cartucce/Cartucho - PXC150	156,00

## PRC

Model Modèle Modell Modello Modelo	Description Désignation Beschreibung Descrizione Descripción	List price € Prix de liste € Listenpreis in € Prezzo di listino € P.V.P. €
25200-0150	Kartusche/Cartridge/Cartouche/Cartucce/Cartucho - PRC50	52,00
25200-0175	Kartusche/Cartridge/Cartouche/Cartucce/Cartucho - PRC75	62,00





Sandfilteranlagen / Sand Filter Systems / Groupes de filtration à sable  
Grupos de filtración de arena / Gruppi filtranti a sabbia

## onga® Filtration kits

With 4-way valves - und 4-Wege Ventil - avec vanne 4 voies - valvola a 4 vie  
Con válvula de 4 vías

Model	"Pump Flow Rates at 6 m height"	"Maximum Filter Flow Rates m <sup>3</sup> /h"	Description/Désignation/	List price €
Modèle	"Débit de la pompe à 6 m hmt"	"Débit maximal du filtre en m <sup>3</sup> /h"	Beschreibung/Descripción	Prix de liste €
Modell	"Pumpenleistung in m <sup>3</sup> /h bei 6 m WS"	Maximum	Filter/Filter/Filtre/Filtro	Listenpreis in €
Modello	Flusso max pompa 6m	Flusso max filtro m <sup>3</sup> /h	Pump/Pompes/Pumpe/Bomba	Prezzo di listino €
Modelo	Caudal de la bomba a 6 m altura	Caudal máx. filtro m <sup>3</sup> /h		P.V.P. €
PA15-BR462	6	5	Ø15" (380mm) + BR462E (0,25kW / 230Volt)	470,00
PA17-BR463	8	7,4	Ø17" (430mm) + BR463E (0,37kW / 230Volt)	506,00
PA20-BR464	11	10	Ø20" (500mm) + BR464E (0,55kW / 230Volt)	562,00
PA20-BR465	13	10	Ø20" (500mm) + BR465E (0,75kW / 230Volt)	600,00
PA24-BR465	13	14,2	Ø24" (600mm) + BR465E (0,75kW / 230Volt)	685,00

Pumpe auf separater Plattform montiert / Pump and Filter fixed individually upon two platform bases / Pompe et filtre assemblés sur deux plates-formes séparées / Bomba y filtro fijados individualmente sobre la plataformas de dos bases



## onga® Filtration kits

With 6-way valves - und 6-Wege Ventil - avec vanne 6 voies - valvola a 6 vie  
Con válvula de 6 vías

Model	"Pump Flow Rates at 6 m height"	"Maximum Filter Flow Rates m <sup>3</sup> /h"	Description/Désignation/	List price €
Modèle	"Débit de la pompe à 6 m hmt"	"Débit maximal du filtre en m <sup>3</sup> /h"	Beschreibung/Descripción	Prix de liste €
Modell	"Pumpenleistung in m <sup>3</sup> /h bei 6 m WS"	Maximum	Filter/Filter/Filtre/Filtro	Listenpreis in €
Modello	Flusso max pompa 6m	Flusso max filtro m <sup>3</sup> /h	Pump/Pompes/Pumpe/Bomba	Prezzo di listino €
Modelo	Caudal de la bomba a 6 m altura	Caudal máx. filtro m <sup>3</sup> /h		P.V.P. €
PPA15-BR462	6	5	Ø15" (380mm) + BR462E (0,25kW / 230Volt)	502,00
PPA17-BR463	8	7,4	Ø17" (430mm) + BR463E (0,37kW / 230Volt)	538,00
PPA20-BR464	11	10	Ø20" (500mm) + BR464E (0,55kW / 230Volt)	605,00
PPA20-BR465	13	10	Ø20" (500mm) + BR465E (0,75kW / 230Volt)	637,00
PPA24-BR465	13	14,2	Ø24" (600mm) + BR465E (0,75kW / 230Volt)	724,00

Pumpe auf separater Plattform montiert / Pump and Filter fixed individually upon two platform bases / Pompe et filtre assemblés sur deux plates-formes séparées / Bomba y filtro fijados individualmente sobre la plataformas de dos bases







## Side mount

### Vanne Latérale Montaggio laterale Montaje lateral

Model Modèle Modell Modello Modelo	Description Désignation Beschreibung Descrizione Descripción	List price € Prix de liste € Listenpreis in € Prezzo di listino € P.V.P. €
14965-SM10	6-way valve - 1 1/2" Connection / 6 Wegeventil - 1 1/2" Anschluß Vanne 6-voies - 1 1/2" Raccordement / 6 vie - connessione 1 1/2" Válvula 6 vías – conexión 1 1/2"	67,00
14965-SM20	6-way valve - 2" Connection / 6 Wegeventil - 2" Anschluß Vanne 6-voies - 2" Raccordement / Válvula 6 vías – conexión 2"	115,00
WC212-144P	6-way valve - 2" Connection, BSP / 6 Wegeventil - 2" Anschluß, BSP Vanne 6-voies - 2" Raccordement, BSP / Válvula 6 vías – conexión 2", BSP	145,00
WC212-154P	6-way valve - 2" for System3 (S7MD60 / S7MD72) 6 Wegeventil - 2" Anschluß für System3 (S7MD60/S7MD72) Vanne 6-voies - 2" pour System3 (S7MD60/S7MD72) Válvula 6 vías – conexión 2" para System3 (S7MD60/S7MD72)	145,00
14965-SK30	6-way valve - 3" Connection, 90 mm Union / 6 Wegeventil - 3" Anschluß, 90 mm Klebemuffe /Vanne 6-voies - 3" Raccordement, 90 mm Union / Válvula 6 vías – conexión 3", unión de 90 mm	725,00
14965-SM30	6-way valve - 3" Connection, BSP / 6 Wegeventil - 3" Anschluß, BSP Vanne 6-voies - 3" Raccordement, BSP / Válvula 6 vías – conexión 3", BSP	758,00

## Top mount

### Vanne Top Montaggio superiore Montaje superior

Model Modèle Modell Modello Modelo	Description Désignation Beschreibung Descrizione Descripción	List price € Prix de liste € Listenpreis in € Prezzo di listino € P.V.P. €
14965-50TM	6-way valve - 1 1/2" Connection, 50mm Union Vanne 6-voies - 1 1/2" Raccordement, 50mm Union 6 Wegeventil - 1 1/2" Anschluß, inkl. 50mm Klebemuffe Válvula 6 vías conexión 1 1/2", unión 50 mm	99,00
14965-TM10	6-way valve - 1 1/2" Connection, BSP / Vanne 6-voies - 1 1/2" Raccordement, BSP / 6 Wegeventil - 1 1/2" Anschluß, BSP / Válvula 6 vías – conexión 1 1/2", BSP	85,00
14965-TM20	6-way valve - 2" Connection, BSP / Vanne 6-voies - 2" Raccordement, BSP / 6 Wegeventil - 2" Anschluß, BSP / Válvula 6 vías – conexión 2", BSP	124,00
14965-TM10E	4-way valve - 1 1/2" Connection, BSP / Vanne 4-voies - 1 1/2" Raccordement, BSP / 4 Wegeventil - 1 1/2" Anschluß, BSP / Válvula 4 vías – conexión 1 1/2", BSP	67,00

Automatic controlled Top mount and Side mount 6-way valves available on request / Les vannes 6-voies commandées automatiquement sont livrables sur commande / Automatisch gesteuerte Top mount und Side mount Ventile auf Anfrage lieferbar / Valvole a 6 vie automatiche sono disponibili a richiesta / Válvulas de montaje lateral y superior automáticas disponibles a petición



## Swimming Pool Pumps / Schwimmbadpumpen / Pompes pour piscine Pompe per piscina / Bombas para piscinas

### 5P2R

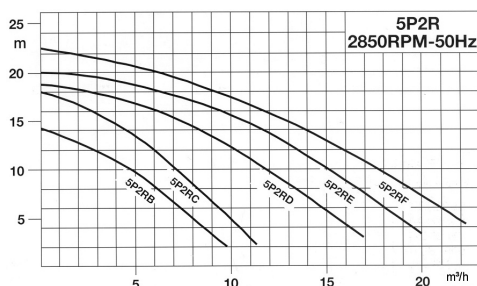
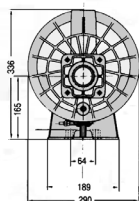

Discharge 1 1/2" BSP -40-

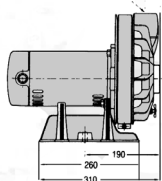

Suction  
1 1/2" BSP

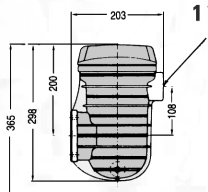

Model Modell Modèle Modello Modelo	Flow Rates m3/h at 8 m height Leistung in m3/h bei 8 m WS Débit à 8 m hmt Flusso in m3/h a 8m prevalenza Caudal a 8 m de altura	kW	Motor / Moteur / Motore Volt / Voltage / Voltaje / Tensione	List price € Listenpreis in € Prix de liste € Prezzo di listino € P.V.P. €
5P2RB-1	6	0,25kW	220-240V	447,00
5P2RB-3	6	0,25kW	380-420V	447,00
5P2RC-1	8,5	0,37kW	220-240V	449,00
5P2RC-3	8,5	0,37kW	380-420V	449,00
5P2RD-1	13,5	0,55kW	220-240V	465,00
5P2RD-3	13,5	0,55kW	380-420V	459,00
5P2RE-1	16,5	0,75kW	220-240V	499,00
5P2RE-3	16,5	0,75kW	380-420V	495,00
5P2RF-1	19,5	1,10kW	220-240V	556,00
5P2RF-3	19,5	1,10kW	380-420V	540,00

### S5P2R

Salt Water  
Salzwasser  
Eau salée  
Per acqua salata  
Agua salada

Model Modell Modèle Modello Modelo	Flow Rates m3/h at 8 m height Leistung in m3/h bei 8 m WS Débit à 8 m hmt Flusso in m3/h a 8m prevalenza Caudal a 8 m de altura	kW	Motor / Moteur / Motore Volt / Voltage / Voltaje / Tensione	List price € Listenpreis in € Prix de liste € Prezzo di listino € P.V.P. €
S5P2RB-1	6	0,25kW	220-240V	505,00
S5P2RB-3	6	0,25kW	380-420V	487,00
S5P2RC-1	8,5	0,37kW	220-240V	510,00
S5P2RC-3	8,5	0,37kW	380-420V	497,00
S5P2RD-1	13,5	0,55kW	220-240V	523,00
S5P2RD-3	13,5	0,55kW	380-420V	500,00
S5P2RE-1	16,5	0,75kW	220-240V	563,00
S5P2RE-3	16,5	0,75kW	380-420V	528,00
S5P2RF-1	19,5	1,10kW	220-240V	602,00
S5P2RF-3	19,5	1,10kW	380-420V	567,00

### 5P2R

Two speed

Model Modell Modèle Modello Modelo	Flow Rates m3/h at 8 m height Leistung in m3/h bei 8 m WS Débit à 8 m hmt Flusso in m3/h a 8m prevalenza Caudal a 8 m de altura	kW	Motor / Moteur / Motore Volt / Voltage / Voltaje / Tensione	List price € Listenpreis in € Prix de liste € Prezzo di listino € P.V.P. €
5P2RE-3-2	16,5	0,75kW	380-420V	689,00
5P2RF-1-2	19,5	1,10kW	220-240V	990,00
5P2RF-3-2	19,5	1,10kW	380-420V	938,00



## Swimming Pool Pumps / Schwimmbadpumpen / Pompes pour piscine Pompe per piscina / Bombas para piscinas

### 5P6R

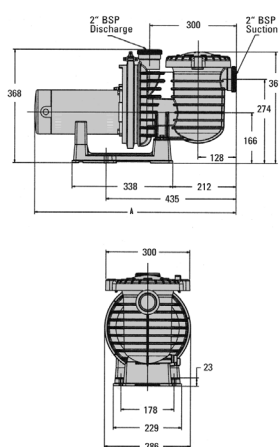
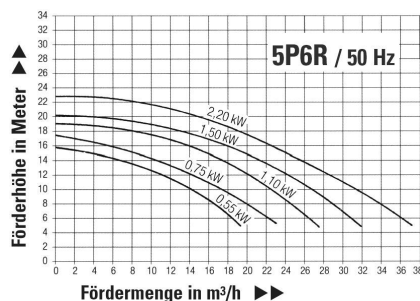

Model Modell Modèle Modello Modelo	Flow Rates m3/h at 8 m height Leistung in m3/h bei 8 m WS Débit à 8 m hmt Flusso in m3/h a 8m prevalenza Caudal a 8 m de altura	Motor / Moteur / Motore Volt / Voltage / Voltaje / Tensione	List price € Listenpreis in € Prix de liste € Prezzo di listino € P.V.P. €
5P6RD-1	16,5	0,55kW	584,00
5P6RD-3	16,5	0,55kW	527,00
5P6RE-1	20	0,75kW	614,00
5P6RE-3	20	0,75kW	551,00
5P6RF-1	24,5	1,10kW	670,00
5P6RF-3	24,5	1,10kW	557,00
5P6RG-1	29	1,50kW	728,00
5P6RG-3	29	1,50kW	643,00
5P6RH-1	34	2,20kW	781,00
5P6RH-3	34	2,20kW	712,00

### SW5P6R

#### For Seawater applications

Spezialpumpen für Meerwasser

Pour applications à l'eau de mer

Per applicazioni con acqua di mare

Para aplicaciones con agua de mar



Model Modell Modèle Modello Modelo	Flow Rates m3/h at 8 m height Leistung in m3/h bei 8 m WS Débit à 8 m hmt Flusso in m3/h a 8m prevalenza Caudal a 8 m de altura	Motor / Moteur / Motore Volt / Voltage / Voltaje / Tensione	List price € Listenpreis in € Prix de liste € Prezzo di listino € P.V.P. €
SW5P6RD-1	16,5	0,55kW	740,00
SW5P6RD-3	16,5	0,55kW	684,00
SW5P6RE-1	20	0,75kW	759,00
SW5P6RE-3	20	0,75kW	700,00
SW5P6RF-1	24,5	1,10kW	820,00
SW5P6RF-3	24,5	1,10kW	718,00
SW5P6RG-1	29	1,50kW	880,00
SW5P6RG-3	29	1,50kW	796,00
SW5P6RH-1	34	2,20kW	922,00
SW5P6RH-3	34	2,20kW	858,00



## Swimming Pool Pumps / Schwimmbadpumpen / Pompes pour piscine Pompe per piscina / Bombas para piscinas

### 5MPR

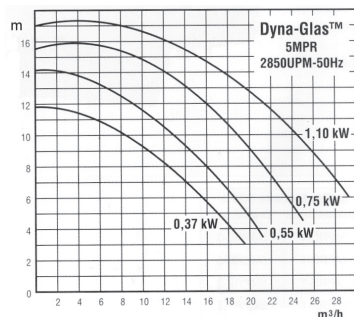

Model Modell Modèle Modello Modelo	Flow Rates m <sup>3</sup> /h at 8 m height Leistung in m <sup>3</sup> /h bei 8 m WS Débit à 8 m hmt Flusso in m <sup>3</sup> /h a 8m prevalenza Caudal a 8 m de altura	kW	Motor / Moteur / Motore Volt / Voltage / Voltaje / Tensione	List price € Listenpreis in € Prix de liste € Prezzo di listino € P.V.P. €
5MPRC-1	12	0,37kW	220-240V	463,00
5MPRC-3	12	0,37kW	380-420V	460,00
5MPRD-1	16	0,55kW	220-240V	475,00
5MPRD-3	16	0,55kW	380-420V	463,00
5MPRE-1	21	0,75kW	220-240V	515,00
5MPRE-3	21	0,75kW	380-420V	497,00
5MPRF-1	27	1,10kW	220-240V	566,00
5MPRF-3	27	1,10kW	380-420V	538,00

### 5JWP

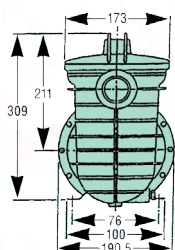
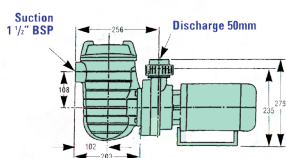
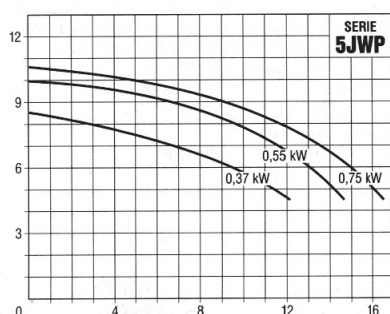

Model Modell Modèle Modello Modelo	Flow Rates m <sup>3</sup> /h at 8 m height Leistung in m <sup>3</sup> /h bei 8 m WS Débit à 8 m hmt Flusso in m <sup>3</sup> /h a 8m prevalenza Caudal a 8 m de altura	kW	Motor / Moteur / Motore Volt / Voltage / Voltaje / Tensione	List price € Listenpreis in € Prix de liste € Prezzo di listino € P.V.P. €
5JWPC-1	9,5	0,37kW	220-240V	420,00
5JWP C-3	9,5	0,37kW	380-420V	385,00
5JWPD-1	13	0,55kW	220-240V	425,00
5JWPD-3	13	0,55kW	380-420V	390,00
5JWPE-1	15	0,75kW	220-240V	430,00
5JWPE-3	15	0,75kW	380-420V	400,00





## Swimming Pool Pumps / Schwimmbadpumpen / Pompes pour piscine Pompe per piscina / Bombas para piscinas

### 5ABG

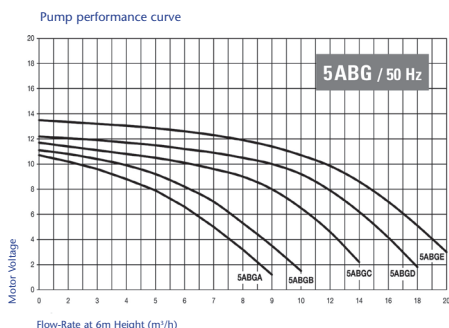
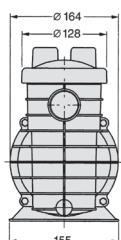
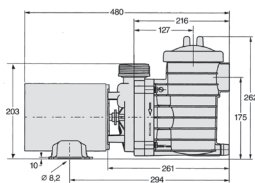

Model Modell Modèle Modello Modelo	Flow Rates m <sup>3</sup> /h at 8 m height Leistung in m <sup>3</sup> /h bei 8 m WS Débit à 8 m hmt Flusso in m <sup>3</sup> /h a 8m prevalenza Caudal a 8 m de altura	kW	Motor / Moteur / Motore Volt / Voltage / Voltaje / Tensione	List price € Listenpreis in € Prix de liste € Prezzo di listino € P.V.P. €
5ABGA-1	5	0,18kW	220-240V	198,00
5ABGB-1	6,5	0,25kW	220-240V	205,00
5ABGC-1	10	0,37kW	220-240V	220,00
5ABGD-1	13,2	0,55kW	220-240V	250,00
5ABGE-1	16,5	0,75kW	220-240V	260,00

### 5BR

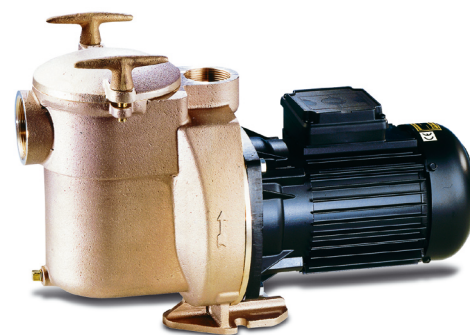
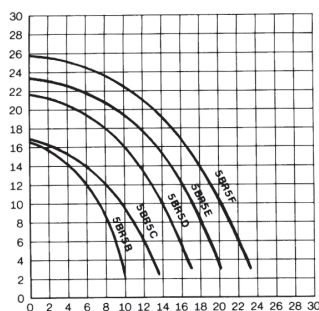
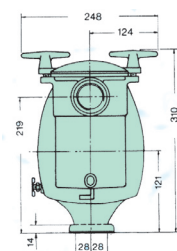
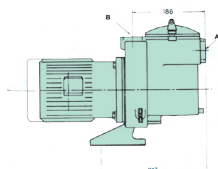

Model Modell Modèle Modello Modelo	Flow Rates m <sup>3</sup> /h at 8 m height Leistung in m <sup>3</sup> /h bei 8 m WS Débit à 8 m hmt Flusso in m <sup>3</sup> /h a 8m prevalenza Caudal a 8 m de altura	kW	Motor / Moteur / Motore Volt / Voltage / Voltaje / Tensione	List price € Listenpreis in € Prix de liste € Prezzo di listino € P.V.P. €
5BRB-1	8	0,25kW	220-240V	765,00
5BRB-3	8	0,25kW	380-420V	715,00
5BRC-1	11	0,37kW	220-240V	770,00
5BRC-3	11	0,37kW	380-420V	720,00
5BRD-1	15	0,55kW	220-240V	800,00
5BRD-3	15	0,55kW	380-420V	735,00
5BRE-1	18	0,75kW	220-240V	850,00
5BRE-3	18	0,75kW	380-420V	755,00
5BRF-1	21	1,10kW	220-240V	880,00
5BRF-3	21	1,10kW	380-420V	800,00



## Swimming Pool Pumps / Schwimmbadpumpen / Pompes pour piscine Pompe per piscina / Bombas para piscinas

### onga® BR400E

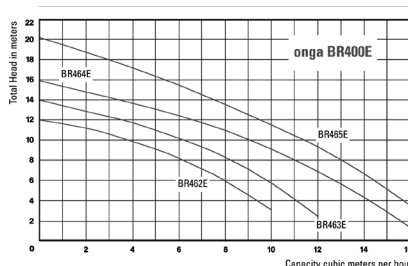

Model Modell Modèle Modello Modelo	Flow Rates m³/h at 8 m height Leistung in m³/h bei 8 m WS Débit à 8 m hmt Flusso in m³/h a 8m prevalenza Caudal a 8 m de altura	kW	Motor / Moteur / Motore Volt / Voltage / Voltaje / Tensione	List price € Listenpreis in € Prix de liste € Prezzo di listino € P.V.P. €
BR462E	6	0,25kW	220-240V	190,00
BR463E	8	0,37kW	220-240V	197,00
BR464E	11	0,55kW	220-240V	230,00
BR465E	13	0,75kW	220-240V	240,00

### onga® 800E

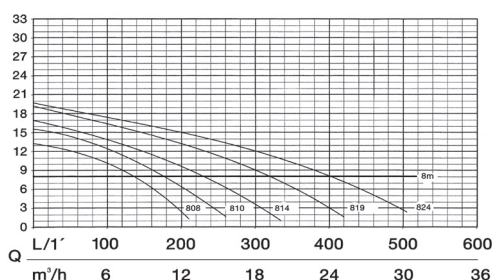

Model Modell Modèle Modello Modelo	Flow Rates m³/h at 8 m height Leistung in m³/h bei 8 m WS Débit à 8 m hmt Flusso in m³/h a 8m prevalenza Caudal a 8 m de altura	kW	Motor / Moteur / Motore Volt / Voltage / Voltaje / Tensione	List price € Listenpreis in € Prix de liste € Prezzo di listino € P.V.P. €
808-1	8	0,37kW	220-240V	315,00
808-3	8	0,37kW	380-420V	315,00
810-1	10	0,55kW	220-240V	335,00
810-3	10	0,55kW	380-420V	335,00
814-1	14	0,75kW	220-240V	375,00
814-3	14	0,75kW	380-420V	375,00
819-1	19	1,10kW	220-240V	420,00
819-3	19	1,10kW	380-420V	420,00
824-1	24	1,50kW	220-240V	465,00
824-3	24	1,50kW	380-420V	465,00

### LTP

Model Modell Modèle Modello Modelo	Flow Rates m³/h at 8 m height Leistung in m³/h bei 8 m WS Débit à 8 m hmt Flusso in m³/h a 8m prevalenza Caudal a 8 m de altura	kW	Motor / Moteur / Motore Volt / Voltage / Voltaje / Tensione	List price € Listenpreis in € Prix de liste € Prezzo di listino € P.V.P. €
LTP400SE	7,2	0,37kW	220-240V	166,00
LTP550SE	10,8	0,55kW	220-240V	184,00
LTP750SE	15	0,75kW	220-240V	204,00



Pump-Exchange Set / Austauschatz / Jeu d'échange  
Set ricambio pompa / Juego recambio para bombas

## 5P2R

Model Modell Modèle Modello Modelo	Flow Rates m3/h at 8 m height Leistung in m3/h bei 8 m WS Débit à 8 m hmt Flusso in m3/h a 8m prevalenza Caudal a 8 m de altura	kW	Motor / Moteur / Motore Volt / Voltage / Voltaje / Tensione	List price € Listenpreis in € Prix de liste € Prezzo di listino € P.V.P. €
5P2RB-1-X	6	0,25kW	220-240V	410,00
5P2RB-3-X	6	0,25kW	380-420V	354,00
5P2RC-1-X	8,5	0,37kW	220-240V	426,00
5P2RC-3-X	8,5	0,37kW	380-420V	361,00
5P2RD-1-X	13,5	0,55kW	220-240V	426,00
5P2RD-3-X	13,5	0,55kW	380-420V	369,00
5P2RE-1-X	16,5	0,75kW	220-240V	481,00
5P2RE-3-X	16,5	0,75kW	380-420V	393,00
5P2RF-1-X	19,5	1,10kW	220-240V	525,00
5P2RF-3-X	19,5	1,10kW	380-420V	435,00

## S5P2R

Model Modell Modèle Modello Modelo	Flow Rates m3/h at 8 m height Leistung in m3/h bei 8 m WS Débit à 8 m hmt Flusso in m3/h a 8m prevalenza Caudal a 8 m de altura	kW	Motor / Moteur / Motore Volt / Voltage / Voltaje / Tensione	List price € Listenpreis in € Prix de liste € Prezzo di listino € P.V.P. €
S5P2RB-1-X	6	0,25kW	220-240V	452,00
S5P2RB-3-X	6	0,25kW	380-420V	392,00
S5P2RC-1-X	8,5	0,37kW	220-240V	468,00
S5P2RC-3-X	8,5	0,37kW	380-420V	403,00
S5P2RD-1-X	13,5	0,55kW	220-240V	468,00
S5P2RD-3-X	13,5	0,55kW	380-420V	410,00
S5P2RE-1-X	16,5	0,75kW	220-240V	523,00
S5P2RE-3-X	16,5	0,75kW	380-420V	436,00
S5P2RF-1-X	19,5	1,10kW	220-240V	566,00
S5P2RF-3-X	19,5	1,10kW	380-420V	477,00

## 5BR

Model Modell Modèle Modello Modelo	Flow Rates m3/h at 8 m height Leistung in m3/h bei 8 m WS Débit à 8 m hmt Flusso in m3/h a 8m prevalenza Caudal a 8 m de altura	kW	Motor / Moteur / Motore Volt / Voltage / Voltaje / Tensione	List price € Listenpreis in € Prix de liste € Prezzo di listino € P.V.P. €
5BRB-1-X	8	0,25kW	220-240V	450,00
5BRB-3-X	8	0,25kW	380-420V	412,00
5BRC-1-X	11	0,37kW	220-240V	462,00
5BRC-3-X	11	0,37kW	380-420V	412,00
5BRD-1-X	15	0,55kW	220-240V	483,00
5BRD-3-X	15	0,55kW	380-420V	430,00
5BRE-1-X	18	0,75kW	220-240V	540,00
5BRE-3-X	18	0,75kW	380-420V	445,00
5BRF-1-X	21	1,10kW	220-240V	585,00
5BRF-3-X	21	1,10kW	380-420V	490,00



## Prefilter and gasket kits / Vorfilterkörper und Dichtungssätze Préfiltres et joints / Prefiltri e cestelli / Prefiltros y juego de juntas

### Prefilter / Vorfilterkörper / Prefiltre / Prefiltri / Prefiltro

Model Modèle Modell Modello Modelo	Description Désignation Beschreibung Descrizione Descripción	List price € Prix de liste € Listenpreis in € Prezzo di listino € P.V.P. €
PKG115	Ø 5" - Eingang 1 1/2" für 5P2R / 5JWP Ø 5" - Suction 1 1/2" for 5P2R / 5JWP Ø 5" - Aspiration 1 1/2" pour 5P2R / 5JWP Ø 5" - Aspirazione 1 1/2" per 5P2R / 5JWP Ø 5" - Succión 1 1/2" para 5P2R / 5JWP	56,00
PKG161W	Ø 6" - Eingang 2" für 5P2R Ø 6" - Suction 2" for 5P2R Ø 6" - Aspiration 2" pour 5P2R Ø 6" - Aspirazione 1 1/2" per 5P2R Ø 6" - Succión 2" para 5P2R	90,00

### Gasket kits / Dichtungssätze / Set de joints série / Serie cestelli / Juego de juntas de serie

Model Modèle Modell Modello Modelo	Description Désignation Beschreibung Descrizione Descripción	List price € Prix de liste € Listenpreis in € Prezzo di listino € P.V.P. €
PP5000	Gasket kit Series/Set de Joints Série/Dichtungssatz Serie/Serie cestelli/Juego de juntas de serie	5BR 34,00
PP2000	Gasket kit Series/Set de Joints Série/Dichtungssatz Serie/Serie cestelli/Juego de juntas de serie	5JWP 28,00
PP3000	Gasket kit Series/Set de Joints Série/Dichtungssatz Serie/Serie cestelli/Juego de juntas de serie	5MPR 33,00
PP1000	Gasket kit Series/Set de Joints Série/Dichtungssatz Serie/Serie cestelli/Juego de juntas de serie	5P2R 27,00
PP4000	Gasket kit Series/Set de Joints Série/Dichtungssatz Serie/Serie cestelli/Juego de juntas de serie	5P4R 35,00
PP6000	Gasket kit Series/Set de Joints Série/Dichtungssatz Serie/Serie cestelli/Juego de juntas de serie	5P6R 35,00
PP1000S	Gasket kit Series/Set de Joints Série/Dichtungssatz Serie/Serie cestelli/Juego de juntas de serie	S5P2R 36,00
PP4000SW	Gasket kit Series/Set de Joints Série/Dichtungssatz Serie/Serie cestelli/Juego de juntas de serie	SW5P4R 160,00
PP6000SW	Gasket kit Series/Set de Joints Série/Dichtungssatz Serie/Serie cestelli/Juego de juntas de serie	SW5P6R 160,00
PP3000	Gasket kit Series/Set de Joints Série/Dichtungssatz Serie/Serie cestelli/Juego de juntas de serie	5TPE 33,00
PPBR400E	Gasket kit Series/Set de Joints Série/Dichtungssatz Serie/Serie cestelli/Juego de juntas de serie	BR400E 19,00
PP700E	Gasket kit Series/Set de Joints Série/Dichtungssatz Serie/Serie cestelli/Juego de juntas de serie	800E 19,00
PP800A	Gasket kit Series/Set de Joints Série/Dichtungssatz Serie/Serie cestelli/Juego de juntas de serie	808-810 24,00
PP800B	Gasket kit Series/Set de Joints Série/Dichtungssatz Serie/Serie cestelli/Juego de juntas de serie	814-824 24,00
NO1000	Gasket kit Series/Set de Joints Série/Dichtungssatz Serie/Serie cestelli/Juego de juntas de serie	SWIMMEY 19,00
U79-11	Schlüssel für Vorfilter 5" + 6" / Lid wrench 5" + 6" / Clef de serrage 5" + 6" Kunststoff - Filterpalette 1000 x 495 x 50 mm / llave de cierre 5"+ 6"	23,00
PF500	Plastic filter platform 1000 x 495 x 50 mm Platine en plastique pour le filtre 1000 x 495 x 50 mm Kunststoff - Filterpalette 1000 x 1000 x 50 mm Plataforma de plástico para filtro 1000x495x50 mm	36,00
PF1000	Plastic filter platform 1000 x 1000 x 50 mm Platine en plastique pour le filtre 1000 x 1000 x 50 mm Plataforma de plástico para filtro 1000x1000x50 mm	65,00





## Water Test Kits / Wasser Testgeräte / Trousses d'analyses / Test kit analisi acqua / Kit de pruebas

Model Modèle Modell Modello Modelo	Description Désignation Beschreibung Descrizione Descripción	Quantity per case Conditionnement Bestellmenge Quantità per caso Cantidad por caja	List price € Prix de liste € Listenpreis in € Prezzo di listino € P.V.P. €
AQ 1001	Duo Test Kit for Cl + pH with two 15cm <sup>3</sup> bottles utilizing OTO and phenol red / Duo Test Kit für Cl + pH mit zwei 15cm <sup>3</sup> Flaschen OTO und Phenol Rot / Duo Test Kit para Cl + pH con dos botellas de 15 cm <sup>3</sup> utilizando OTO y fenol rojo / Doppio Test Kit per Cl + pH con n.2 flaconi 15cm <sup>3</sup> con OTO e Rosso fenolo	24	5,50
AQ 1014	Duo Test Kit DPD for Cl + pH. Includes 20 DPD tablets and 15cm <sup>3</sup> bottle of phenol red / Duo Test Kit DPD für Cl + pH. 20 DPD-Tablette und 15cm <sup>3</sup> Phenol Rot enthalten / Doppio Test Kit DPD per Cl + pH. incluso 20 pastiglie DPD e flacone da 15cm <sup>3</sup> di rosso fenolo / Duo Test Kit DPD para Cl + pH que incluye 20 tabletas de DPD y botella de fenol rojo	24	5,50
AQ 12001	Duo Test Refill - 15cm <sup>3</sup> . Refill bottle of OTO and phenol red. For use in AQ1001 / Duo Test Ersatzflaschen für AQ1001 mit je 15cm <sup>3</sup> OTO und Phenol Rot. / Doppio Flacone 15cm <sup>3</sup> OTO e rosso fenolo di ricambio per AQ1001 / Repuesto Duo Test Kit - botella de repuesto de 15 cm <sup>3</sup> de OTO y fenol rojo	24	2,10
AQ 12004	Refill bottle of OTO. For use in AQ1001 OTO Ersatzflaschen mit 15cm <sup>3</sup> OTO für AQ1001 / OTO - 15cm <sup>3</sup> . / Flacone 15cm <sup>3</sup> OTO di ricambio per AQ1001 / Repuesto Duo Test Kit - botella de repuesto de 15 cm <sup>3</sup> de OTO	24	1,00
AQ 12006	OTO - 30cm <sup>3</sup> . Refill bottle of OTO / Ersatzflaschen mit 30cm <sup>3</sup> OTO / OTO - 30cm <sup>3</sup> . Flacone ricambio / Botella de repuesto de 30 cm <sup>3</sup> de OTO	12	1,60
AQ 12011	Phenol red - 15cm <sup>3</sup> . Refill bottle of phenol red. For use in AQ1001 + AQ1014 / Ersatzflaschen mit 15cm <sup>3</sup> Phenol Rot. Für AQ1001 + AQ1014 / Rosso fenolo - 15cm <sup>3</sup> . Flacone ricambio.per uso in AQ1001 + AQ1014 / Repuesto Duo test kit y Duo Test Kit DPD - botella de repuesto 15 cm <sup>3</sup> de fenol	24	1,05
AQ 12013	Refill bottle of phenol red Phenol red - 30cm <sup>3</sup> . / Ersatzflaschen mit 30cm <sup>3</sup> Phenol Rot / Rosso fenolo - 30cm <sup>3</sup> . Flacone ricambio	12	1,60
AQ 12040	DPD Tablets. 40tablets of DPD #1 for use with AQ1014 / 40 Ersatztabletten DPD #1 für AQ1014 / Pastiglie DPD. 40 pastiglie di DPD #1 per uso con AQ1014 / Repuesto Duo Test Kit Duo - 40 tabletas DPD1 de repuesto	12	4,00

## Telescopic poles / Teleskopstange / Manche télescopique / Aste telescopische / Pertigas telescópicas

Model Modèle Modell Modello Modelo	Description Désignation Beschreibung Descrizione Descripción	Quantity per case Conditionnement Bestellmenge Quantità per caso Cantidad por caja	List price € Prix de liste € Listenpreis in € Prezzo di listino € P.V.P. €
AQ 4001	Telepole. Blue anodized finish with internal cams 2,40m - 4,60m Teleskopstange mit Bajonettverschluss, 2fach ausziehbar. Blau und natur eloxiert / Manche télescopique / Pertiga telescópica anonizada 2,40m-4,60m AZUL con levas internas	12	21,00
AQ 4002	1,80m - 3,40m Telepole. Blue anodized finish with internal cams / Teleskopstange mit Bajonettverschluss. Blau und natur eloxiert / Manche télescopique / Pertiga telescópica anonizada azul con levas internas	12	15,00
AQ 4007	1,20m - 2,40m Telepole. Blue anodized finish with internal cams / Teleskopstange mit Bajonettverschluss. Blau und natur eloxiert / Manche télescopique / Pertiga telescópica anonizada azul con levas internas	12	13,00
AQ 4006	2,40m - 4,60m Telepole. External locking cam won't slip. Bicycle grip Teleskopstange mit Gewindeverschraubung. Blau und natur eloxiert / Manche télescopique / Pertiga telescópica 2,40m-4,60m con fijación externa antideslizante y cierre clip	12	21,00
AQ 4019	1,80m - 3,40m Telepole. External locking cam won't slip. Bicycle grip / Teleskopstange mit Gewindeverschraubung. Blau und natur eloxiert / Manche télescopique / Pertiga telescópica 1,80m-3,40m con fijación externa antideslizante y cierre clip	12	16,00
AQ 4020	1,20m - 2,40m Telepole. External locking cam won't slip. Bicycle grip / Teleskopstange mit Gewindeverschraubung. Blau und natur eloxiert / Manche télescopique / Pertiga telescópica 1,20m-2,40m con fijación externa antideslizante y cierre clip	12	12,00



## Vacuum hoses / Schlauch / Tuyau flottant / Tubi d'aspirazione / Mangueras de aspiración

Model	Description	Quantity per case	List price €
Modèle	Désignation	Conditionnement	Prix de liste €
Modell	Beschreibung	Bestellmenge	Listenpreis in €
Modello	Descrizione	Quantità per caso	Prezzo di listino €
Modelo	Descripción	Cantidad por caja	P.V.P. €
AQ 13575D	7,5 m Vac hose/Schlauch blau/Tuyau flottant/Manguera de aspiración/Tubi d'aspirazione	6	36,00
AQ 13509D	9,0 m Vac hose/Schlauch blau/Tuyau flottant/Manguera de aspiración/Tubi d'aspirazione	6	47,00
AQ 13510D	10,0 m Vac hose/Schlauch blau/Tuyau flottant/Manguera de aspiración/Tubi d'aspirazione	6	50,00
AQ 13512D	12,0 m Vac hose/Schlauch blau/Tuyau flottant/Manguera de aspiración/Tubi d'aspirazione	6	63,00
AQ 13515D	15,0 m Vac hose/Schlauch blau/Tuyau flottant/Manguera de aspiración/Tubi d'aspirazione	6	78,00

## Pool vacuums / Bodensauger / Balai de fond / Aspiratori / Limpiapiscinas de aspiración

Model	Description	Quantity per case	List price €
Modèle	Désignation	Conditionnement	Prix de liste €
Modell	Beschreibung	Bestellmenge	Listenpreis in €
Modello	Descrizione	Quantità per caso	Prezzo di listino €
Modelo	Descripción	Cantidad por caja	P.V.P. €
AQ 3002	Kunststoff Bodensauger / Vinyl liner vacuum / Balai de fond en plastique Aspiratori / Limpiafondos de plástico	6	16,60
AQ 3028	Long-Life 8 Rad Bodensauger / Long-Life vacuum cleaner. Flexible 8 wheel concrete vacuum cleaner with pool-saver side bumpers / Nettoyeur de fond à 8 roulettes / Limpiafondos de larga duración flexible con 8 ruedas y topes laterales	6	19,50
AQ 3055	Transparenter Bodensauger / Triangular see-through vacuum cleaner for liner pools / Balai triangulaire transparent / Limpiafondos triangular transparente para piscinas revestidas	6	25,00
AQ 3113	Bodensauger mit seitlichen Bürsten / Vacuum with brushes on each side / Balai / Limpiafondos con cepillos en cada lado	6	15,00

## Thermometer / Thermometers / Thermomètre / Termometri

Model	Description	Quantity per case	List price €
Modèle	Désignation	Conditionnement	Prix de liste €
Modell	Beschreibung	Bestellmenge	Listenpreis in €
Modello	Descrizione	Quantità per caso	Prezzo di listino €
Modelo	Descripción	Cantidad por caja	P.V.P. €
AQ 2004	Thermometer Delux mit Chromoberfläche und bruchsicherer Kunststoffblende. / Deluxe chrome brass thermometer. Solid brass thermometer with chrome finish and shatterproof plastic lens. Includes both Fahrenheit and Celcius scales. / Delux en Chrome / Termómetro "Deluxe" de cobre con acabado en cromo y lentes inastillables. Incluye escala en Celsius y Fahrenheit.	12	6,00
AQ 2023	Spa Buoy. Schwimmender Thermometer mit großer Skala und bruchsicherem weißen Kunststoffgehäuse. / Spa Buoy thermometer, Large, easy-to-read Fahrenheit and Celcius scales / Termómetro boya para Spas, grande y de fácil lectura de las escalas C y F	12	3,90
AQ 2024	Jumbo Jim - Thermometer mit großer Skala und bruchsicherem weißen Kunststoffgehäuse inklusive Befestigungsschnur / Jumbo Jim thermometer. Durable injection-molded housing with weighted body and large, easy-to-ready Fahrenheit and Celcius scales / Termómetro de cubierta de inyección moldeada, con cuerpo pesado y grande y de fácil lectura de las escalas C y F	12	3,20
AQ 2062	"Rundthermometer zur Tiefenmessung (30cm) mit Schwimmring Round-thermometer for in-depth reading (30cm) with floating ring" / Termómetro redondo para lectura en profundidad (30 cm) con anillo flotador	12	56,00



## Laubkescher / Leaf Skimmer / Epuisette / Retini / Atrapahojas

Model	Description	Quantity per case	List price €
Modèle	Désignation	Conditionnement	Prix de liste €
Modell	Beschreibung	Bestellmenge	Listenpreis in €
Modello	Descrizione	Quantità per caso	Prezzo di listino €
Modelo	Descripción	Cantidad por caja	P.V.P. €
AQ 6001	Laubkescher flache Ausführung. Aluminiumverstärker Rahmen mit weißem Kunststoff-Rand. / Leaf Skimmer. Rugged aluminium-frame leaf skimmer with white plastic rim. / Epuisette de surface Atrapahojas con marco de aluminio rugoso y bordes blancos de plástico	6	8,50
AQ 6003	Bodenkescher tiefe Ausführung. Aluminiumverstärkter Rahmen mit weißem Kunststoff-Rand. / Leaf Rake. Rugged aluminium-frame ground cleaner with heavy duty bag and white plastic rim. / Epuisette de fond Atrapahojas con marco de aluminio rugoso, bolsa resistente y bordes blancos de plástico	6	10,50
AQ 6004P	Kunststoffbodenkescher - flach. Rahmenkonstruktion aus einem Stück. Gewebstes Kunststoffnetz. / Leaf Skimmer - Plain. Ultra-light and durable one-piece molded frame is practically indestructible. / Epuisette en plastique Atrapahojas ultraligero y resistente con marco de plástico inyectado de una pieza	6	3,50
AQ 6005	Handkescher mit Magnet. Ideal zum Auffangen von Metallteilen. Kescher wie AQ6004P. Komplett mit Aluminiumstange 1,2m lang. / Magnet Trap Hand Skimmer. Sturdy 1,20m pole mounted on no-mar molded frame with reversible net. Built-in magnet at tip of skimmer / Atrapahojas de mano robusto con periga de 1.2 m enmarcada en el marco con red reversible	6	7,50



## Wallbrush / Reinigungsbürste / Brosse de nettoyage / Spazzole / Cepillos

Model	Description	Quantity per case	List price €
Modèle	Désignation	Conditionnement	Prix de liste €
Modell	Beschreibung	Bestellmenge	Listenpreis in €
Modello	Descrizione	Quantità per caso	Prezzo di listino €
Modelo	Descripción	Cantidad por caja	P.V.P. €
AQ 7002	Reinigungsbürste. Leicht gebogen, zur gründlichen Reinigung von Ecken. Verstärkter Rücken und Universaladapter aus Aluminium. Wallbrush. Curved blue back with die-cast reinforcement. No sharp edges / Brosse de nettoyage 457 mm / Cepillo de pared con base curvada azul, reforzado en aluminio y sin vértices afilados	12	9,00
AQ 7008	Algenbürste. Mit Borsten aus rostfreien Stahl. Universaladapter aus Aluminium. / Algae brush. Straight blue back with die-cast aluminium reinforcement. No sharp edges / Brosse contre les algues 152 mm Cepillo para algas con base rígida azul, reforzado en aluminio y sin vértices afilados	12	11,00
AQ 7009	Reinigungsbürste. Gefertigt aus einem Stück, leicht gebogen, Borsten aus PVC / Wallbrush. One-piece molded white body, has curved ends and no sharp edges / Brosse de nettoyage 457 mm / Cepillo de pared de una pieza de plástico moldeado con curvas redondeadas y sin vértices afilados	12	5,00





Maintenance accessories / Zubehör  
Matériel d'entretien / Accessori / Accesorios

## Floating Dispensers / Schwimmende Chlordosierer / Doseurs flottant

Dosatori galleggianti / Dispensadores flotantes

Model	Description	Quantity per case	List price €
Modèle	Désignation	Conditionnement	Prix de liste €
Modell	Beschreibung	Bestellmenge	Listenpreis in €
Modello	Descrizione	Quantità per caso	Prezzo di listino €
Modelo	Descripción	Cantidad por caja	P.V.P. €
AQ 10047	Dosierschwimmer mit Verstellring (bis 1 kg) mit Klarsichtdeckel Floating dispenser with adjustment ring and see-through cover / Doseur flottant Dispensador flotante con anillo ajustable y cubierta transparente	12	9,00

## Accessories and Parts / Austausch- und Zubehörteile / Pièces de rechange

Accessori e parti di ricambio / Accesorios y piezas de recambio

Model	Description	Quantity per case	List price €
Modèle	Désignation	Conditionnement	Prix de liste €
Modell	Beschreibung	Bestellmenge	Listenpreis in €
Modello	Descrizione	Quantità per caso	Prezzo di listino €
Modelo	Descripción	Cantidad por caja	P.V.P. €
AQ 10013	Universal - Adapter / Steerable vacuum handle / Adaptateur universel Adapter universal / Adaptador universal	12	2,00
AQ 10041	Kwik Snap Spring / Adaptador cierre clip	12	0,80
AQ 10500	Kwik Snap Spring - Bulk / Adaptador cierre clip - bulk	48	0,30



# Warranty conditions for pentair water europe products

## Warranties and liability of the seller

### Introduction

In the present document the name Pentair Water Europe refers to the legal Entities producing, distributing and selling Pentair Water and outsourced products.

In general none of the products made by Pentair Water Europe is a finished good meant to be sold directly to consumers. Pentair Water Europe manufactures, distributes and sells components mainly meant to be part of larger equipments, which are sold to commercial partners (i.e. distributors and/or OEMs). Exceptions to the above warranty conditions will be regulated by specific agreements.

This warranty supersedes all previous publications.

### Warranty Obligations granted by Pentair Water Europe

The products are guaranteed against defects arising from defective materials or workmanship for the following period starting from the day of shipment. Below the main product range manufactured or distributed by Pentair Water Europe. The warranty period refers to the most restrictive case within each product family (the warranty period relevant to each brand is stated in the specific warranty terms of the single brand):

- Valves (FLECK, SIATA): 5 years;
- Electronic boards (FLECK, SIATA): 18 months;
- Motors (FLECK, SIATA): 3 years;
- Polyglass pressure vessels, composite pressure vessels, polyester vessels, expansion tanks (STRUCTURAL, WELLMATE): 5 years;
- Vinylester vessels, special vessels, distribution systems, spare parts (STRUCTURAL): 2 years;
- Cabinets and brine tanks (PENTAIR PRODUCTS & ACCESSORIES): 2 years;
- Pumps (FLOTEC, NOCCHI, RIVER, SHURFLO): 1 year or more according to the type;
- Swimming pool automatic cleaners (LEGEND, NEW KREEPY KRAULY, E-Z VAC, KREEPY CADET, HOSES, LETRO SWEEP): 2 years or more according to the type;
- Underwater lightings for swimming pools (SAM, SAL, AQUALUMINATOR, AMERLITE, FIBERWORKS): 2 years;
- Swimming pool pumps (CHALLENGER, ULTRAFLOW, WHISPERFLOW, PINNACLE, HYDRONAUT, TRITON JET): 2 years or more according to the type;
- Swimming pool filters (TRITON, TAGELUS, NAUTILUS FNS, FNS PLUS, CLEAN&CLEAR PLUS, AZUR): 2 years or more according to the type;
- Swimming pool automatic sanitizers (AUTOMATIC FEEDER 300/320, COMMERCIAL FEEDER, SALT CHLORINATOR): 2 years or more according to the type;
- Swimming pool heating equipments (MINIMAX HEATPUMP): 2 years;
- Swimming pool controls (COMPOOL, INTELLI TOUCH): 2 years;
- Other filters, cartridges (PENTEK, EVERPURE): 1 year or more according to the type;

Any other Pentair brand or family of product will be guaranteed by Pentair Water Europe no less than what is stated by the EU directive on this subject, by National laws and by commercial habits of Pentair.

This warranty is limited to the repair or replacement of the defective parts or to the issue of a credit note for the amount invoiced to the Customers, if judged necessary by the Seller, without any further obligation whatsoever.

The goods will be considered as being accepted if no written claim has been made by the Purchaser within 60 days from the receipt of the good.

The warranty is granted to the initial Purchaser and will become void when the goods are transferred to a third party.

The warranty is only valid provided that the goods are used in accordance with the purpose and with the limits they have been constructed for and proposed by the Seller to the Purchaser.

The warranty is valid only if the goods are provided with their original label of identification with which they were shipped from Pentair locations. Should this not be available (removed, illegible) any arrangement will have to be discussed and agreed with your Pentair correspondent.

Any irregular use of the goods will automatically cause the warranty to become void (as a partial and not complete example of the above one can state improper repackaging, improper shipping, misapplication, misuse, abuse, negligence, accidental damage, fire, acts of God or other circumstances outside the control of Pentair Water Europe).

The Purchaser commits himself to take properly care of the goods, to respect the maintenance, to follow the guidelines of the Seller and to inform the Seller immediately of any defective part or any damage.

In case of litigation, the applicable law as well as the competent Court will be the one of the Country where sits the Pentair Water Europe Company which has supplied the goods.

### Warranties or Representations by Others

No dealer or other person has any authority to make any different warranties or representations concerning Pentair Water Europe Products. Accordingly, Pentair Water Europe nor any of its entities are to be held responsible for any such warranties or representation.

### Return of the goods

No goods may be forwarded back to the Seller without the prior written authorization by the latter, so called Return Material Authorization (RMA).

This authorization does not imply any liability, whether direct or indirect, apparent or hidden, of the Seller and does not suspend in any event the payment owed by the Purchaser at the date they are due.

Upon receipt of the written authorization by the Seller specifying also the address to which the defective item/s may be shipped, the Purchaser will send the item/s to the address indicated together with a copy of the RMA received by Pentair Water Europe. This need to be applied externally on the box or supplied with the shipping documents.

In case of requests of RMA for returns of new, non defective material due to mistakes of Pentair Water Europe or of the Purchaser the RMA will have to be asked within 60 days from the receipt of the good and sent back within 30 days from the receipt of the RMA.

In case of requests of RMA for returns of defective material (under or out of warranty) the RMA can be asked at any time and the item/s returned within 30 days as previously stated..

### Freight costs

In case of new material to be returned to Pentair because of Customer's mistake, freight costs will be at customer's expense.

In case of new material to be returned to Pentair because of Pentair's mistake, freight costs will be at Pentair's expense.

In case of defective material under warranty to be returned to Pentair, freight costs will be at Pentair's expense both ways.

In case of defective material out of warranty to be returned to Pentair, freight costs will be at Customer's expense both ways.

### Other rights

This warranty gives you specific legal rights as above described. In addition, consumer's rights are protected where applicable, following European Directives or, in absence of, National laws.

# Gewährleistungsbedingungen für Pentair Water Europe-Produkte

## Gewährleistungsverpflichtung des Verkäufers

### Einleitung

Im vorliegenden Schriftstück bezieht sich der Name Pentair Water Europe auf die Pentair Water Europe Gruppe gehörenden Unternehmen, die Pentair Water-Erzeugnisse sowie im Rahmen von Outsourcing hergestellte Produkte fertigen, vertreiben und verkaufen.

Pentair Water Europe-Produkte sind generell keine fertigen Erzeugnisse, die für den Verkauf an den Endverbraucher gedacht sind. Pentair Water Europe fertigt, vertreibt und verkauft grundsätzlich Komponenten für den Einbau in größere Systeme oder Anlagen, die an Handelspartner verkauft werden [wie z. B. Vertriebspartner und/oder OEM (Originalhersteller)]. Eventuelle Ausnahmen von den obigen Gewährleistungsbedingungen werden durch gesonderte Vereinbarungen geregelt.

Diese Gewährleistungsbedingungen ersetzen – soweit zulässig – die gesetzlichen Regelungen sowie alle vorausgegangenen Gewährleistungs- / oder Garantiebedingungen von Pentair Water Europe.

### Gewährleistung von Pentair Water Europe

Im Fall von Material- oder Verarbeitungsfehlern gilt für alle Produkte eine Gewährleistung von unten aufgeführter Dauer, welche mit dem Versandtag beginnt. Es folgt eine Aufstellung der wichtigsten Produkte, die von Pentair Water Europe gefertigt und vertrieben werden. Die angegebene Gewährleistungszeit gibt die kürzeste Verjährung innerhalb der jeweiligen Produktfamilie an (die genaue Gewährleistungszeit jeder Marke ist in den gesonderten Gewährleistungsbedingungen der betreffenden Marke aufgeführt):

- Ventile (FLECK, SIATA): 5 Jahre;
- Schaltschränke (FLECK, SIATA): 18 Monate;
- Motoren (FLECK, SIATA): 3 Jahre;
- Druckbehälter aus Polyglass, Verbund-Druckbehälter, Behälter aus Polyester, Expansionstanks (STRUCTURAL, WELLMATE): 5 Jahre;
- Vinylester-Behälter, Spezialbehälter, Verteilersysteme, Ersatzteile (STRUCTURAL): 2 Jahre;
- Boxen und Solebecken (EUROIMPEX): 2 Jahre;
- Pumpen (FLOTEC, NOCCHI, RIVER, SHURFLO): 1 Jahr oder mehr, je nach Typ;
- Automatischer Schwimmbadreiniger (LEGEND, NEW KREEPY KRAULY, E-Z VAC, KREEPY CADET, HOSES, LETRO SWEEP): 2 Jahre oder mehr, je nach Typ;
- Unterwasserbeleuchtung für Schwimmbäder (SAM, SAL, AQUALUMINATOR, AMERLITE, FIBERWORKS): 2 Jahre;
- Schwimmbadpumpen (CHALLENGER, ULTRAFLOW, WHISPERFLOW, PINNACLE, HYDRAUNAUT, TRITON JET): 2 Jahre oder mehr, je nach Typ;
- Schwimmbadfilter (TRITON, TAGELUS, NAUTILUS FNS, FNS PLUS, CLEAN&CLEAR PLUS, AZUR): 2 Jahre oder mehr, je nach Typ;
- Automatische Desinfektionssysteme für Schwimmbäder (AUTOMATISCHER CHLORDOSIERER 300/320, GROSSER CHLORDOSIERAUTOMAT, ANLAGEN ZUR ELEKTROLYTISCHEN CHLORPRODUKTION): 2 Jahre oder mehr, je nach Typ;
- Schwimmbadheizsysteme (POMPA DI CALORE MINIMAX): 2 Jahre;
- Schwimmbadsteuerungen (COMPOOL, INTELLI TOUCH): 2 Jahre;
- Sonstige Filter, Patronen (PENTEK, EVERPURE): 1 Jahr oder mehr, je nach Typ.

Für jede sonstige Pentair-Marke oder -Produktfamilie besteht eine Gewährleistung mindestens im Rahmen der geltenden EU-Richtlinie, der nationalen Gesetzgebung sowie den kaufmännischen Gepflogenheiten des Hauses Pentair.

Diese Gewährleistung beschränkt sich nach Wahl von Pentair Water Europe auf die Reparatur oder den Austausch der defekten Teile bzw. auf die Ausstellung einer Gutschriftanzeige für den dem Kunden berechneten Betrag, Darüber hinausgehende Verpflichtungen von Pentair Water Europe bestehen nicht.

Die Ware wird als abgenommen betrachtet, sofern der Käufer nicht innerhalb von 60 Tagen nach Wareneingang eine schriftliche Beanstandung absendet.

Die Gewährleistung gilt nur gegenüber dem ursprünglichen Käufer und verfällt bei Weitergabe der Ware an Dritte.

Die Gewährleistung gilt nur unter der Voraussetzung, dass die Ware bestimmungsgemäß sowie innerhalb der Grenzen verwendet wird, für welche sie hergestellt und dem Käufer vom Verkäufer angeboten wurde.

Die Gewährleistung ist nur gültig, wenn die Ware mit dem Original-Kennzeichnungsetikett geliefert wird, mit dem sie von Pentair Water Europe aus versandt wurde. In Ermangelung dieses Etiketts (falls entfernt oder unleserlich) sind mit dem Pentair-Partner gesonderte Vereinbarungen zu treffen.

Jede unsachgemäße Verwendung der Ware führt zum Ausschluss der Gewährleistung (neben weiteren Beispielen gehören hierzu unter anderem: unangemessene Wiederverpackung, ungeeigneter Versand, falsche Anwendung, unsachgemäße Verwendung, Missbrauch, Nachlässigkeit, fahrlässige Beschädigung, Brand, höhere Gewalt oder sonstige Umstände, die sich der Kontrolle von Pentair Water Europe entziehen).

Der Käufer verpflichtet sich, die Ware sachgemäß zu behandeln, die Wartungshinweise zu beachten, die Anweisungen des Verkäufers zu befolgen und Letzteren unverzüglich über jeden etwaigen Defekt oder Schaden zu informieren.

Im Fall eines Rechtsstreits gelten anwendbares Recht und zuständiger Gerichtsstand des Landes, in welchem die Pentair Water Europe-Filiale ansässig ist, welche die Ware geliefert hat.

### Gewährleistungen oder Erklärungen Dritter

Händler oder sonstige Person sind nicht befugt, mit Bezug auf die Pentair Water Europe-Produkte anders lautende Garantien oder Gewährleistungen auszusprechen oder anderweitige Erklärungen abzugeben. Weder Pentair Water Europe noch irgendeine ihrer verbundenen Gesellschaften haften für derartige anders lautenden Erklärungen.

### Warenrücksendung

Warenrücksendungen an den Verkäufer sind nur nach schriftlicher Einwilligung desselben gestattet, welche im Zuge einer sogenannten Materialrücksendungsgenehmigung (RMA: Return Material Authorization) erfolgen muss.

Besagte Genehmigung bedeutet keine Anerkennung eines Gewährleistungsanspruches – weder direkt noch indirekt, weder scheinbar noch verborgen – seitens des Verkäufers und berechtigt den Käufer nicht zur Aussetzung seiner Zahlungsverpflichtungen. Die, bisherige Fälligkeit bleibt weiterhin bestehen.

Bei Erhalt der schriftlichen Genehmigung des Verkäufers, die auch die Lieferanschrift für die Rücksendung des oder der defekten Produkte enthält, verschickt der Käufer die betreffenden Produkte an die angegebene Adresse und fügt der Sendung eine Kopie der von Pentair Water Europe erhaltenen RMA bei. Dieses Schriftstück muss außen am Karton angebracht oder zusammen mit den Versandpapieren geliefert werden.

RMA-Anfragen für die Rücksendung von neuem, nicht defektem Material aufgrund von Fehlern seitens Pentair Water Europe oder des Käufers sind innerhalb von 60 Tagen nach Warenerhalt einzureichen; die Warenrücksendung muss innerhalb von 30 Tagen nach Eingang der RMA stattfinden.

RMA-Anfragen für die Rücksendung von defektem Material (inner- oder außerhalb der Garantie) können jederzeit eingereicht werden; der/die Produkte sind wie oben festgehalten innerhalb von 30 Tagen zurückzusenden.

### Versandkosten

Im Fall einer auf Irrtümer des Kunden zurückzuführenden Rücksendung neuer Materialien an Pentair gehen die Versandkosten zu Lasten des Kunden.

Im Fall einer auf Irrtümer seitens Pentair zurückzuführenden Rücksendung neuer Materialien an Pentair gehen die Versandkosten zu Lasten von Pentair.

Im Fall einer Rücksendung defekter, von der Gewährleistung erfasster Materialien an Pentair gehen die Versandkosten auf dem Hin- und Rückweg zu Lasten von Pentair.

Im Fall einer Rücksendung defekter, nicht von der Gewährleistung erfasster Materialien an Pentair gehen die Versandkosten auf dem Hin- und Rückweg zu Lasten des Kunden.

### Sonstige Rechte

Diese Garantie gewährt dem Verbraucher die oben beschriebenen, spezifischen gesetzlichen Rechte. Die Rechte des Verbrauchers unterliegen in den anwendbaren Fällen zudem dem Schutz der europäischen Richtlinien sowie in deren Ermangelung der nationaler Gesetzgebung.

# Conditions de garantie des produits Pentair Water Europe

## Garanties et obligations du vendeur

### Introduction

Dans ce document, le nom Pentair Water Europe se réfère aux Personnes Juridiques qui produisent, distribuent et vendent les produits Pentair Water ainsi que les produits exécutés par des tiers. Généralement, les produits Pentair Water Europe ne sont jamais des produits finis, prêts pour la vente directe au consommateur. Pentair Water Europe produit, distribue et vend essentiellement des composants à intégrer aux systèmes ou aux équipements plus importants, vendus à des partenaires commerciaux [par exemple aux distributeurs et/ou aux OEM (producteurs d'équipements originaux)]. Les éventuelles exceptions aux susdites conditions de garantie seront régies par des contrats spécifiques. Cette garantie remplace toutes les publications précédentes.

### Garanties offertes par Pentair Water Europe

Les produits sont garantis contre tous vices de construction et de matières premières pendant la période indiquée ci-dessous, à compter du jour de l'expédition. On reporte ci-après une liste des principaux produits fabriqués ou distribués par Pentair Water Europe. La période de garantie indiquée se réfère au cas plus limitatif dans chaque famille de produits (la période de garantie relative à chaque marque est indiquée dans les conditions de garantie spécifiques de chaque marque):

- Vannes de régulation (FLECK, SIATA): 5 ans;
- Cartes électroniques (FLECK, SIATA): 18 mois;
- Moteurs (FLECK, SIATA): 3 ans;
- Bouteilles polyglass, bouteilles spéciales, bouteilles polyester, réservoirs d'expansion (STRUCTURAL, WELLMATE): 5 ans;
- Bouteilles vinylester, bouteilles spéciales, systèmes de distribution, pièces de rechange (STRUCTURAL): 2 ans;
- Compacts et bacs à sel (PENTAIR PRODUCTS & ACCESSORIES): 2 ans;
- Pompes (FLOTEC, NOCCHI, RIVER, SHURFLO): 1 an ou plus, selon le modèle;
- Nettoyeurs automatiques pour piscines (LEGEND, NEW KREEPY KRAULY, E-Z VAC, KREEPY CADET, HOSES, LETRO SWEEP): 2 ans ou plus, selon le modèle;
- Eclairage sous-marin pour piscines (SAM, SAL, AQUALUMINATOR, AMERLITE, FIBERWORKS): 2 ans;
- Pompes pour piscines (CHALLENGER, ULTRAFLOW, WHISPERFLOW, PINNACLE, HYDRAUNAUT, TRITON JET): 2 ans ou plus, selon le modèle;
- Filtres pour piscines (TRITON, TAGELUS, NAUTILUS FNS, FNS PLUS, CLEAN&CLEAR PLUS, AZUR): 2 ans ou plus, selon le modèle;
- Produits pour le traitement automatique de l'eau des piscines (DOSEUR AUTOMATIQUE DE CHLORE 300/200, DOSEUR AUTOMATIQUE DE CHLORE A CAPACITE ELEVEE, SYSTEME DE PRODUCTION ELECTROLYTIQUE DE CHLORE) : 2 ans ou plus, selon le modèle;
- Système de chauffage pour piscines (POMPE A CHALEUR MINIMAX): 2 ans;
- Commandes pour piscines (COMPOOL, INTELLI TOUCH): 2 ans;
- Autres filtres, cartouches (PENTEK, EVERPURE): 1 an ou plus, selon le modèle.

Toute autre marque ou famille de produits Pentair sera garantie au minimum par Pentair Water Europe sur la base de ce qui est prévu par la directive européenne en vigueur en la matière, selon les lois nationales et la pratique commerciale de Pentair.

Cette garantie se limite à la réparation ou au remplacement des parties défectueuses ou à l'émission d'une note de crédit du montant facturé au client, si cela est jugé nécessaire par le vendeur, sans aucune autre obligation.

La marchandise sera considérée comme acceptée si l'Acheteur n'envoie aucune réclamation écrite dans un délai maximum de 60 jours à compter de la réception de la marchandise.

La garantie est valable vis-à-vis du premier Acheteur et devient nulle si la marchandise est transférée à un tiers.

La garantie est uniquement valable si la marchandise est utilisée selon l'emploi prévu et dans les limites pour lesquelles elle a été construite et proposée par le Vendeur à l'Acheteur.

La garantie est uniquement valable si la marchandise est fournie avec son étiquette d'identification originale, avec laquelle elle a été expédiée par les sites de Pentair. Si cette étiquette n'est pas présente, (enlevée ou illisible), des accords spécifiques devront être pris avec le correspondant Pentair.

Toute utilisation impropre de la marchandise provoque automatiquement l'annulation de la garantie (à titre d'exemple mais non limitatif, en cas de réemballage inapproprié, d'expédition inadéquate, d'application erronée, d'utilisation impropre, d'abus, de négligence, d'endommagement accidentel, d'incendie, de causes de force majeure ou autres circonstances indépendantes de la volonté de Pentair Water Europe).

L'Acheteur s'engage à prendre en charge la marchandise de manière appropriée, à respecter les instructions relatives à l'entretien, à suivre les instructions du Vendeur et à informer immédiatement le Vendeur de toute partie défectueuse ou d'un quelconque endommagement.

En cas de conflit, la législation en vigueur et le Tribunal compétent seront ceux du pays dans lequel se trouve la filiale Pentair Water Europe qui a fourni la marchandise.

### Garanties ou déclarations d'autres personnes

Aucun concessionnaire ou autre personne n'a le pouvoir d'accorder des garanties différentes ou de faire des déclarations différentes pour les produits Pentair Water Europe. Par conséquent, ni Pentair Water Europe, ni aucune de ses filiales ne peuvent être considérées responsables des garanties ou des déclarations différentes.

### Renvoi de la marchandise

La marchandise ne peut pas être réexpédiée au Vendeur sans autorisation préalable écrite ainsi que l'Autorisation de Retour de Matériel (RMA).

Cette autorisation n'implique aucune responsabilité, ni directe ni indirecte, apparente ou cachée, de la part du Vendeur et n'interrompt en aucun cas les paiements à la charge de l'Acheteur, valables à leurs dates d'échéance.

Lors de la réception de l'autorisation écrite de la part du Vendeur avec laquelle on précise également l'adresse à laquelle il faut envoyer l'article ou les articles défectueux, l'Acheteur enverra les articles à l'adresse indiquée ainsi qu'une photocopie du RMA reçu par Pentair Water Europe. Ce document doit être appliqué sur l'extérieur de la boîte ou fourni avec les documents d'expédition.

En cas de demandes de RMA pour retourner du matériel neuf non défectueux suite à des erreurs commises par Pentair Water Europe ou par l'Acheteur, le RMA devra être demandé dans un délai de 60 jours à compter de la réception de la marchandise et réexpédié avant 30 jours à compter de la réception du RMA.

En cas de demandes de RMA pour retourner du matériel défectueux (sous garantie ou non) le RMA peut être demandé à tout moment et les articles peuvent être retournés dans un délai de 30 jours comme indiqué ci-dessus.

### Frais d'expédition

En cas de nouveaux matériels à retourner à Pentair suite à une erreur de la part du Client, les frais d'expédition seront à la charge du Client.

En cas de nouveaux matériels à retourner à Pentair suite à une erreur de la part de Pentair, les frais d'expédition seront à la charge de Pentair.

En cas de matériels défectueux sous garantie à retourner à Pentair, les frais d'expédition seront à la charge de Pentair (aller et retour).

En cas de matériels défectueux hors garantie à retourner à Pentair, les frais d'expédition seront à la charge du client (aller et retour).

### Autres droits

Cette garantie accorde au consommateur les droits légaux spécifiques décrits ci-dessus. De plus, les droits du consommateur sont protégés, là où ils sont en vigueur, selon ce qui est prévu par les Directives Européennes ou en leur absence, par les lois nationales.

# Condiciones de garantía para los productos Pentair Water Europe

## Garantías y obligaciones del vendedor

### Introducción

En el presente documento el nombre Pentair Water Europe se refiere a las Personas Jurídicas que producen, distribuyen y venden productos Pentair Water, así como productos fabricados por terceros.

En general, ninguno de los productos Pentair Water Europe puede considerarse como un producto acabado, listo para la venta directa al consumidor final. Fundamentalmente Pentair Water Europe produce, distribuye y vende componentes para integrar en sistemas o equipos mayores, que se venden a colaboradores comerciales [por ejemplo, distribuidores y/o OEM (fabricantes de aparatos originales)]. Toda excepción a estas condiciones de garantía será regulada por acuerdos específicos.

### Garantías ofrecidas por Pentair Water Europe

Los productos están garantizados contra defectos de los materiales o de fabricación durante el período abajo indicado, a contar a partir de la fecha de envío. Detallamos seguidamente los principales productos fabricados o distribuidos por Pentair Water Europe. El período de garantía reflejado, debe entenderse referido al caso más limitativo en el seno de cada familia de productos (el período de garantía relativo a cada marca está indicado en las condiciones de garantía particulares para cada marca en concreto):

- Válvulas (FLECK, SIATA): 5 años;
- Cuadros electrónicos (FLECK, SIATA): 18 meses;
- Motores (FLECK, SIATA): 3 años;
- Recipientes a presión en polyglass, recipientes a presión composite, recipientes en poliéster, depósitos de expansión (STRUCTURAL, WELLMATE): 5 años;
- Recipientes en viniléster, recipientes especiales, sistemas de distribución, recambios (STRUCTURAL): 2 años;
- Cabinets y depósitos para salmuera (PENTAIR PRODUCTS & ACCESSORIES): 2 años;
- Bombas (FLOTEC, NOCCHI, RIVER, SHURFLO): 1 año o más, según el tipo;
- Limpiadores automáticos para piscinas (LEGEND, NEW KREEPY KRAULY, E-Z VAC, KREEPY CADET, HOSES, LETRO SWEEP): 2 años o más, según el tipo;
- Iluminación subacuática para piscinas (SAM, SAL, AQUALUMINATOR, AMERLITE, FIBERWORKS): 2 años;
- Bombas para piscinas (CHALLENGER, ULTRAFLOW, WHISPERFLOW, PINNACLE, HYDRAUNAUT, TRITON JET): 2 años o más, según el modelo;
- Filtros para piscinas (TRITON, TAGELUS, NAUTILUS FNS, FNS PLUS, CLEAN&CLEAR PLUS, AZUR): 2 años o más, según el modelo;
- Dosificadores automáticos para piscinas (DOSIFICADOR AUTOMÁTICO DE CLORO 300/320, DOSIFICADOR AUTOMÁTICO DE CLORO DE ALTA CAPACIDAD, SISTEMA DE PRODUCCIÓN ELECTROLÍTICA DE CLORO): 2 años o más, según el modelo;
- Sistemas de calefacción para piscinas (BOMBA CALORÍFICA MINIMAX): 2 años;
- Programadores para piscinas (COMPOOL, INTELLI TOUCH): 2 años;
- Otros filtros, cartuchos (PENTEK, EVERPURE): 1 año o más, según el modelo.

Cualquier otra marca o familia de productos Pentair, estará garantizada por Pentair Water Europe según lo previsto por la directiva UE vigente en la materia, por las leyes nacionales y por la práctica comercial de Pentair.

Esta garantía está limitada a la reparación o sustitución de las piezas defectuosas, o bien a la emisión de una nota de abono por el importe facturado al Cliente si el Vendedor lo considera necesario, no contando con ningún otro tipo obligación.

Se considerará que la mercancía ha sido aceptada por el Comprador, si éste no envía ninguna reclamación escrita en un plazo de 60 días desde la recepción de la misma.

La garantía es válida sólo para el Comprador inicial y será nula si la mercancía es traspasada a terceros.

La garantía es válida sólo a condición de que la mercancía se utilice según el uso previsto y dentro de los límites para los que ha sido construida y propuesta por el Vendedor al Comprador.

La garantía es válida sólo si la mercancía conserva su etiqueta de identificación original, con la que ha sido despachada desde las sedes de Pentair. Cuando tal etiqueta no esté presente (por haberse sacado o resulte ilegible), deberá comentarse y estipularse acuerdos específicos con el responsable Pentair.

Todo uso impropio de la mercancía causa automáticamente la anulación de la garantía (a título de ejemplo pero no limitativo, podríamos citar un nuevo embalaje inapropiado, envío inadecuado, aplicación incorrecta, uso impropio, abuso, negligencia, daño accidental, incendio, causas de fuerza mayor u otras circunstancias que escapen al control de Pentair Water Europe).

El Comprador se compromete a hacerse cargo de la mercancía de forma adecuada, a respetar las instrucciones sobre el mantenimiento, a seguir las instrucciones del Vendedor y a informar inmediatamente al Vendedor de cualquier pieza defectuosa o dañada.

En caso de controversia, la legislación vigente a aplicar y el Tribunal competente en la materia, serán los del país en el que reside la sucursal Pentair Water Europe que ha suministrado la mercancía.

### Garantías o declaraciones de otros

Ningún concesionario o ninguna otra persona tiene el poder de conceder garantías diferentes o de hacer declaraciones diferentes sobre los productos Pentair Water Europe. Por consiguiente, ni Pentair Water Europe ni ninguna de sus sucursales puede considerarse responsable de ninguna garantía o declaración distinta.

### Devolución de la mercancía

La mercancía no puede devolverse al Vendedor sin una autorización previa y por escrito, que se concederá mediante la Autorización de Devolución de Material (RMA).

Esta autorización no implica ninguna responsabilidad, ni directa ni indirecta, aparente u oculta, del Vendedor y no suspende en ningún caso los pagos a cuenta del Comprador válidos en sus fechas de vencimiento.

A la recepción de la autorización escrita por parte del Vendedor en la que se especificará también la dirección a la que es necesario expedir el artículo o los artículos defectuosos, el Comprador enviará los artículos a la dirección indicada junto con una copia de la RMA recibida de Pentair Water Europe. Este documento deberá pegarse en el exterior la caja o entregarse junto a los documentos de envío.

En caso de solicitudes de RMA para devoluciones de material nuevo, no defectuoso a causa de errores cometidos por Pentair Water Europe o por el Comprador, la RMA deberá solicitarse en un plazo de 60 días desde la recepción de la mercancía y deberá remitirse dentro de 30 días desde la recepción de la RMA.

En caso de solicitudes de RMA para devolución de material defectuoso (en garantía o no) la RMA podrá solicitarse en cualquier momento y los artículos deberán devolverse dentro de 30 días, según lo antes indicado.

### Costes de envío

En caso de nuevos materiales para devolver a Pentair a causa de error del Cliente, los gastos de envío serán por cuenta del Cliente.

En caso de nuevos materiales para devolver a Pentair a causa de errores de Pentair, los gastos de envío serán por cuenta de Pentair.

En caso de materiales defectuosos en garantía para devolver a Pentair, los gastos de envío serán por cuenta de Pentair tanto para la ida como para la vuelta.

En caso de materiales defectuosos no en garantía para devolver a Pentair, los gastos de envío correrán por cuenta del cliente tanto para la ida como para la vuelta.

### Otros derechos

La presente garantía concede al consumidor los derechos legales específicos antes descritos. Además, los derechos del consumidor estarán protegidos, donde sean vigentes, según lo previsto por las Directivas Europeas o, en ausencia de éstas, por las leyes nacionales.